



**SCHONBEK®**

**CHANTANT**  
**CH4803N- \_\_ \_ H**



**T**HIS DESIGN IS THE PROPRIETARY  
TRADE DRESS/TRADE MARK OF  
SWAROVSKI LIGHTING, LTD.

8 Lights  
Height: 52-1/2"  
Length: 43"  
Width: 22"  
Hanging Weight: 61lbs.



**SCHONBEK®**

MAX <u>35</u> W	110-120 V						

**NOTE: INSTALLER IS SOLELY RESPONSIBLE FOR PROPER MOUNTING!**

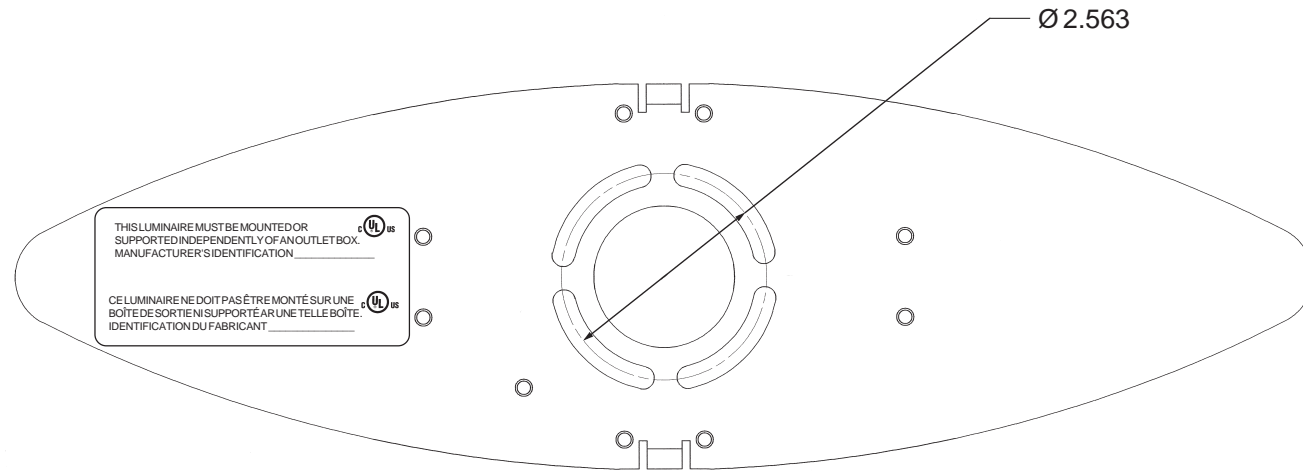

PLAN VIEW OF MOUNTING BRACKET

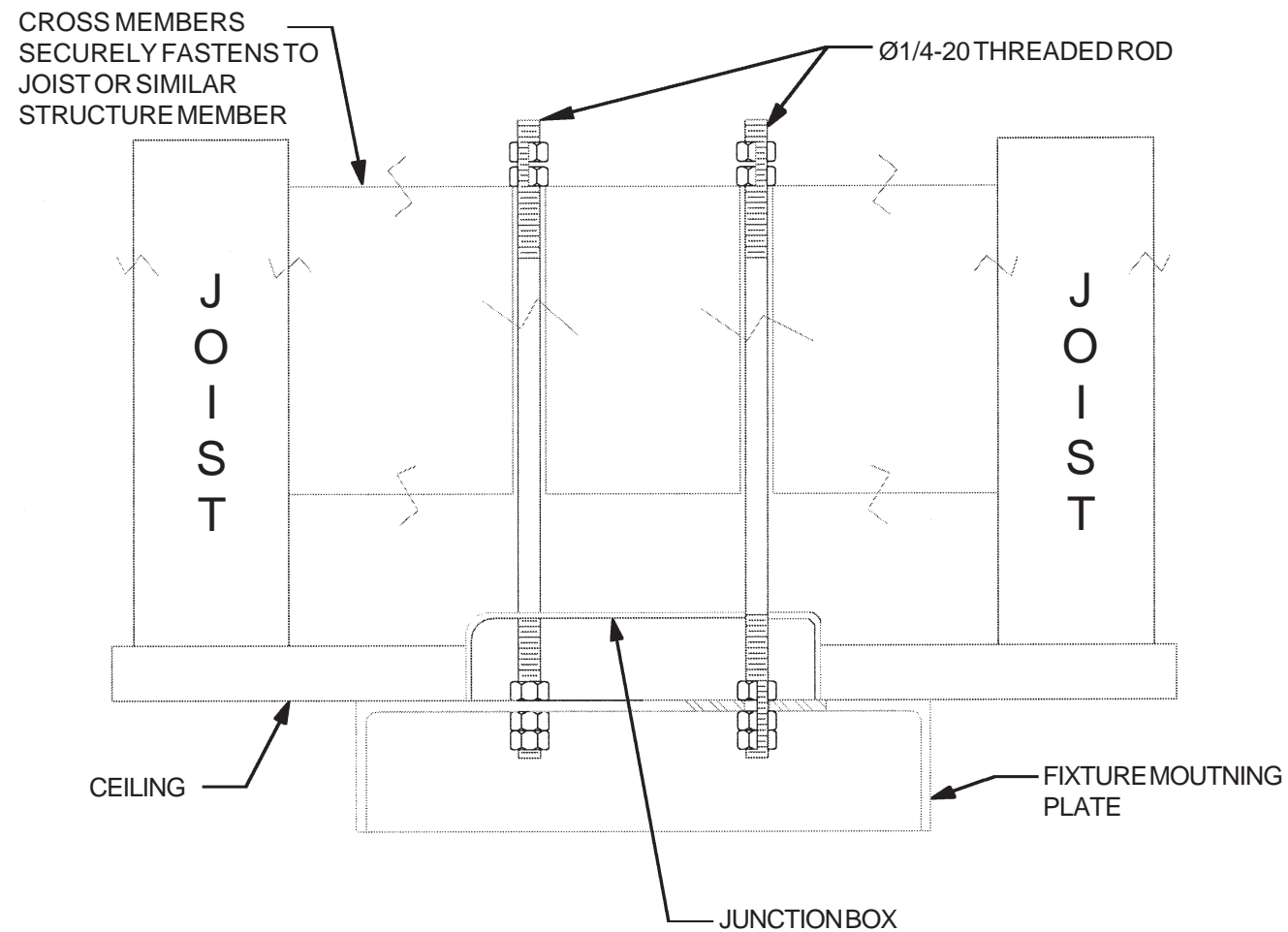

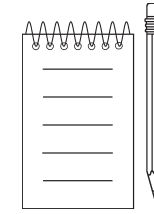

**WARNING:**  
MOUNTING CONFIGURATION AND HARDWARE MUST HOLD 4X THE WEIGHT OF THE FIXTURE. MOUNTING DESIGN AND FIXTURE INSTALLATION SHOULD BE CONDUCTED BY A QUALIFIED LICENSED PROFESSIONAL.

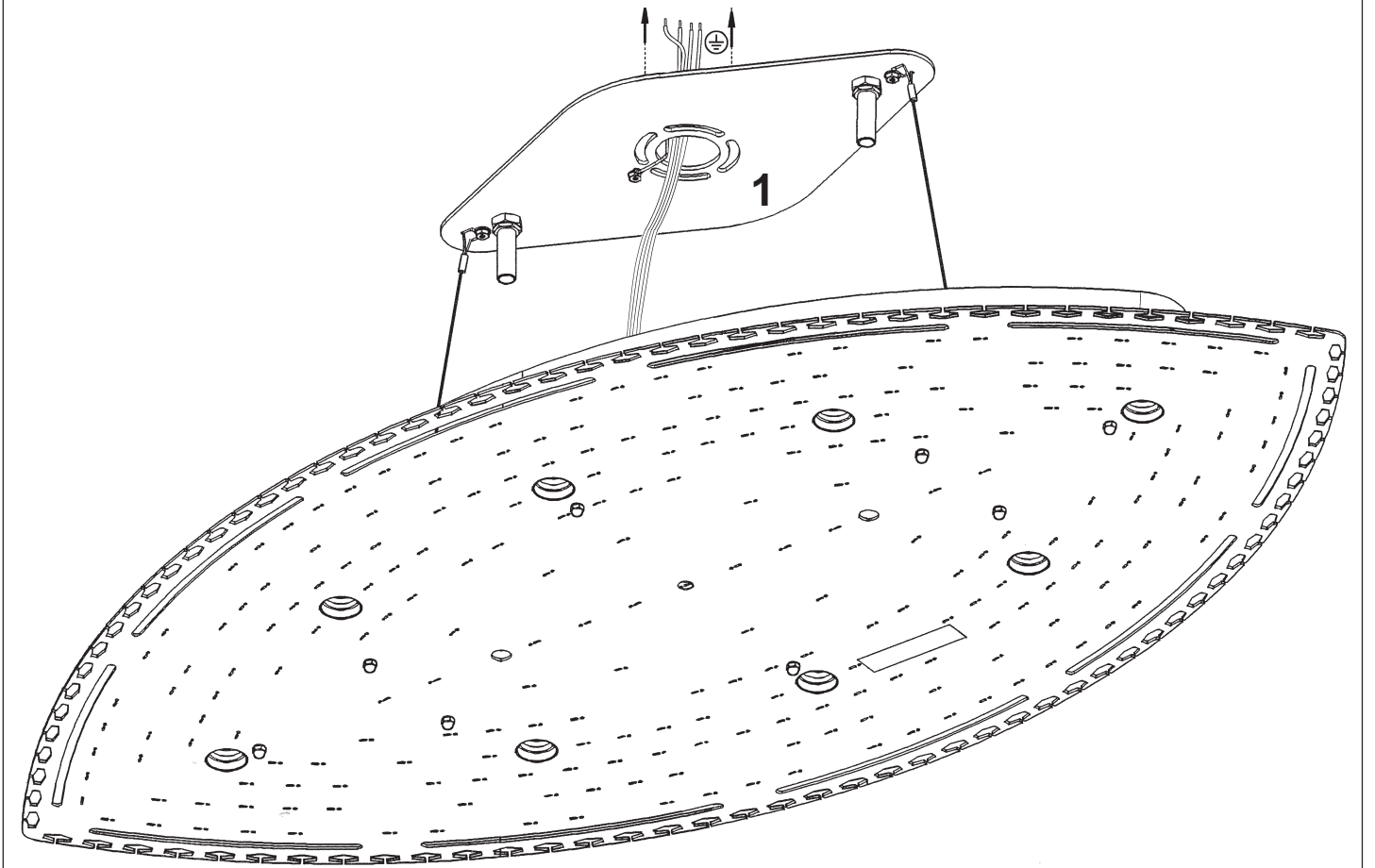
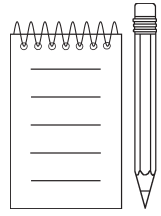

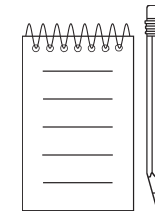
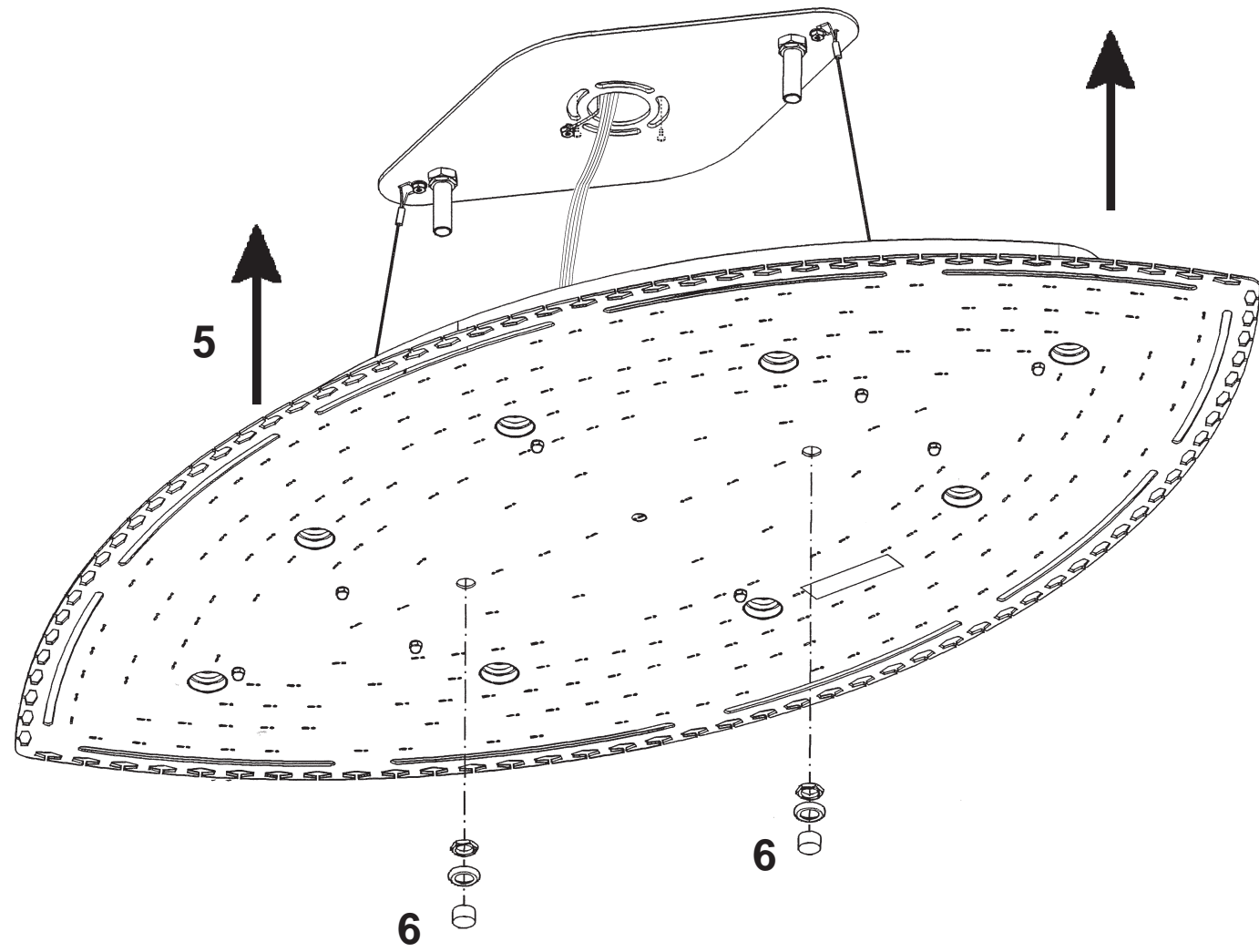
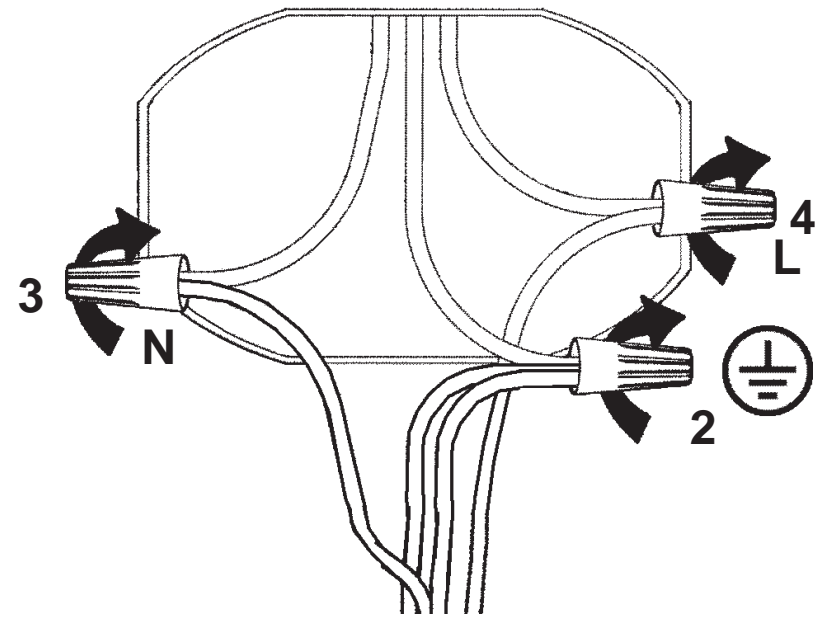

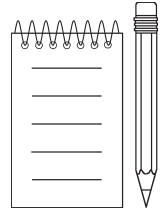

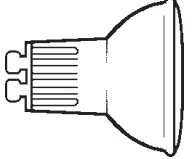

8 X  : GU10 35W MAX 

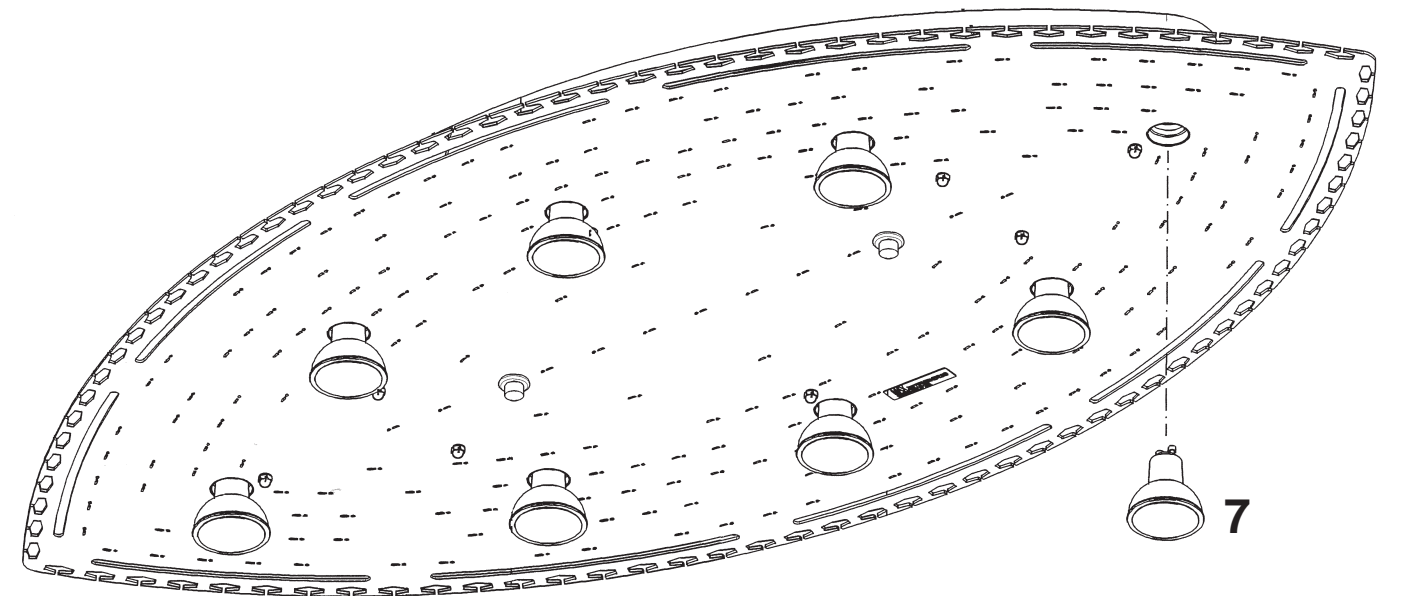

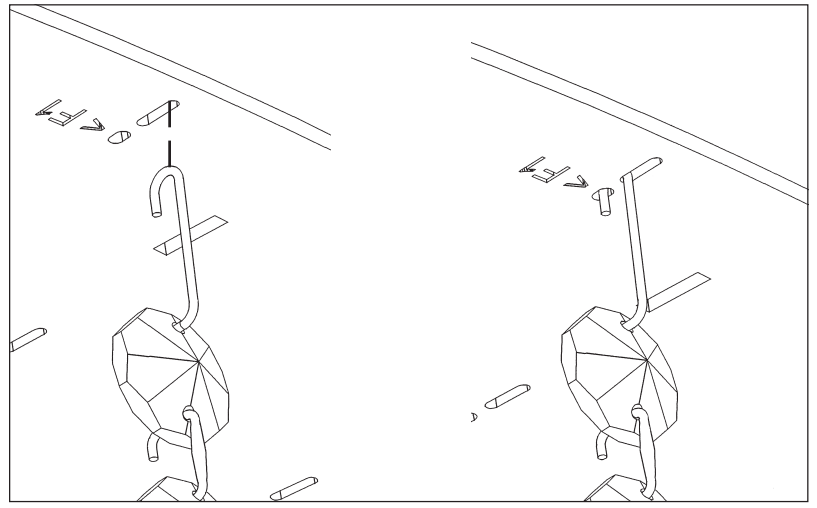
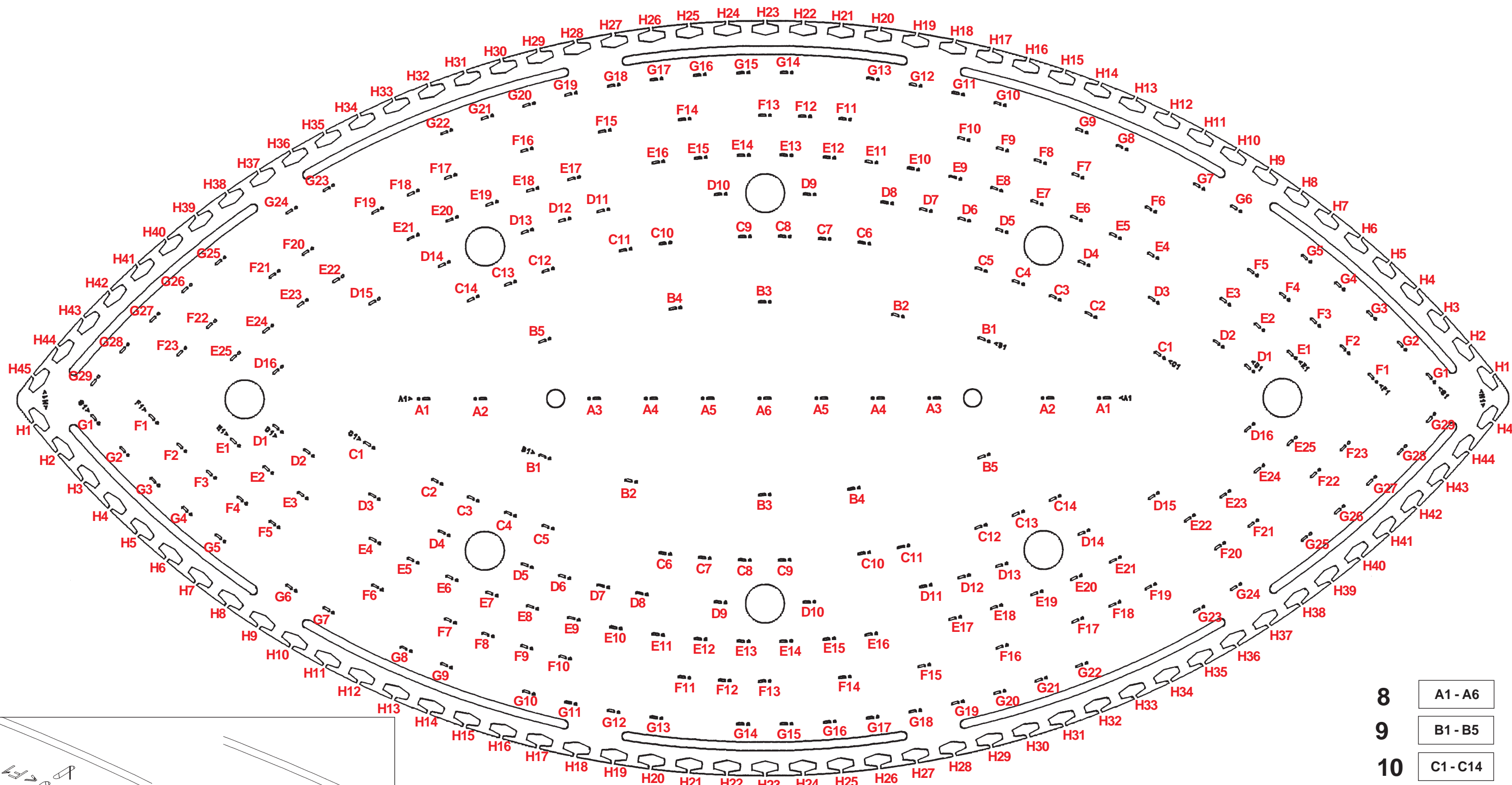

After hanging all trim, remove labels from crystals. If residue remains, wipe off crystal with a soft, dry cloth.

- 8** A1 - A6
- 9** B1 - B5
- 10** C1 - C14
- 11** D1 - D16
- 12** E1 - E25
- 13** F1 - F23
- 14** G1 - G29
- 15** H1 - H45