

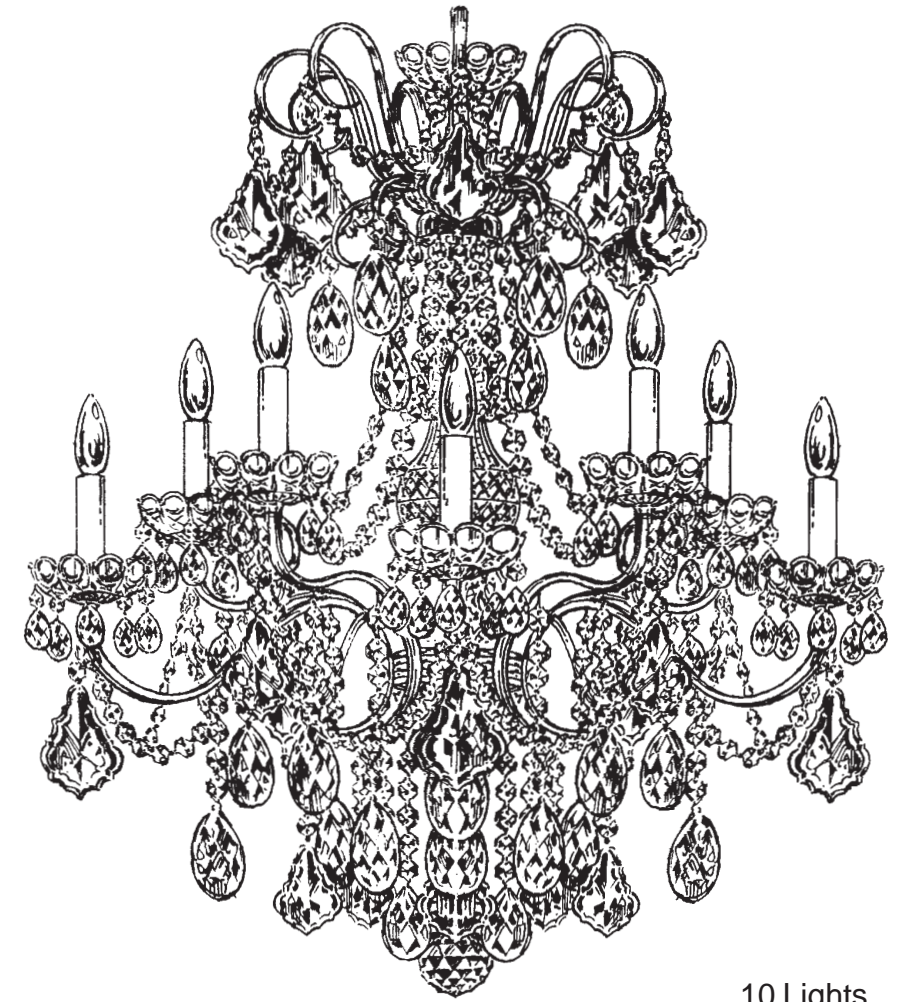

SCHONBEK®

NEW ORLEANS 3657- __ _ H



THIS DESIGN IS THE PROPRIETARY TRADE DRESS/TRADemark OF SWAROVSKI LIGHTING, LTD.

10 Lights
Diameter: 28"
Body Length: 31"
Hanging Weight: 24 lbs.



SCHONBEK®

MAX 60 W		110-120 V						

SCHONBEK® is a member of the Swarovski group.

All electrical components must be installed by a licensed electrician in accordance with the National Electric Code and the appropriate local electrical codes.

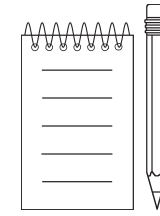
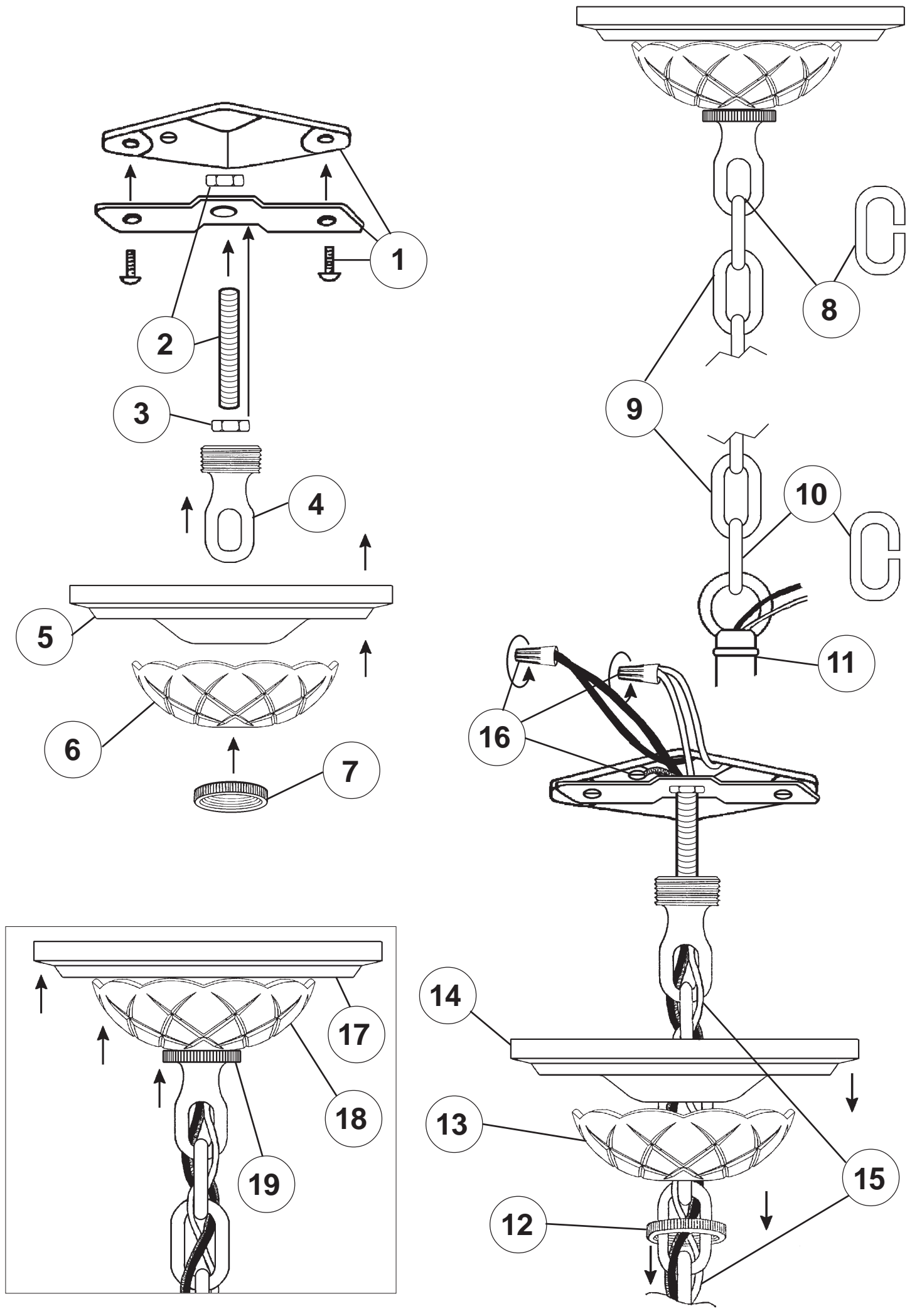

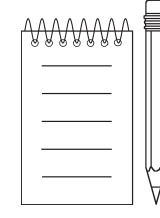
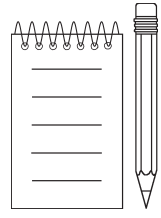

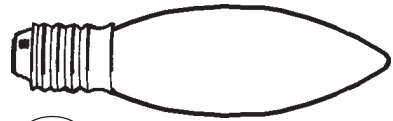

20

You will need 10 - B10
25 Watts Recommended
60 Watts Max

Install bulb and be sure
to test fixture **BEFORE**
trimming.

To protect against beakage and loss during
shipping, the beads are supplied in a plastic bag,
packed with the trim.

21

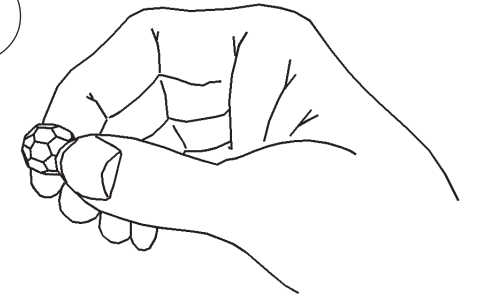

Hold bead at an angle to the arm as shown,
insert one leg of the holder into the arm and,
with a rolling motion across the end of the arm,
push the other leg of the connector into the
arm. Position so that the bead is in the center
of the arm.

