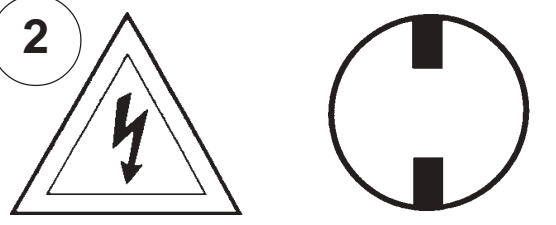
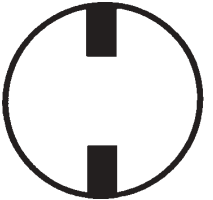

**Instructions for electrician**  
**STEPS 2 - 18**

**WARNING:**

**2**  

**Electrical Danger Turn Power Off**

All electrical components must be installed by a licensed electrician in accordance with the National Electric Code and the appropriate local electrical codes.

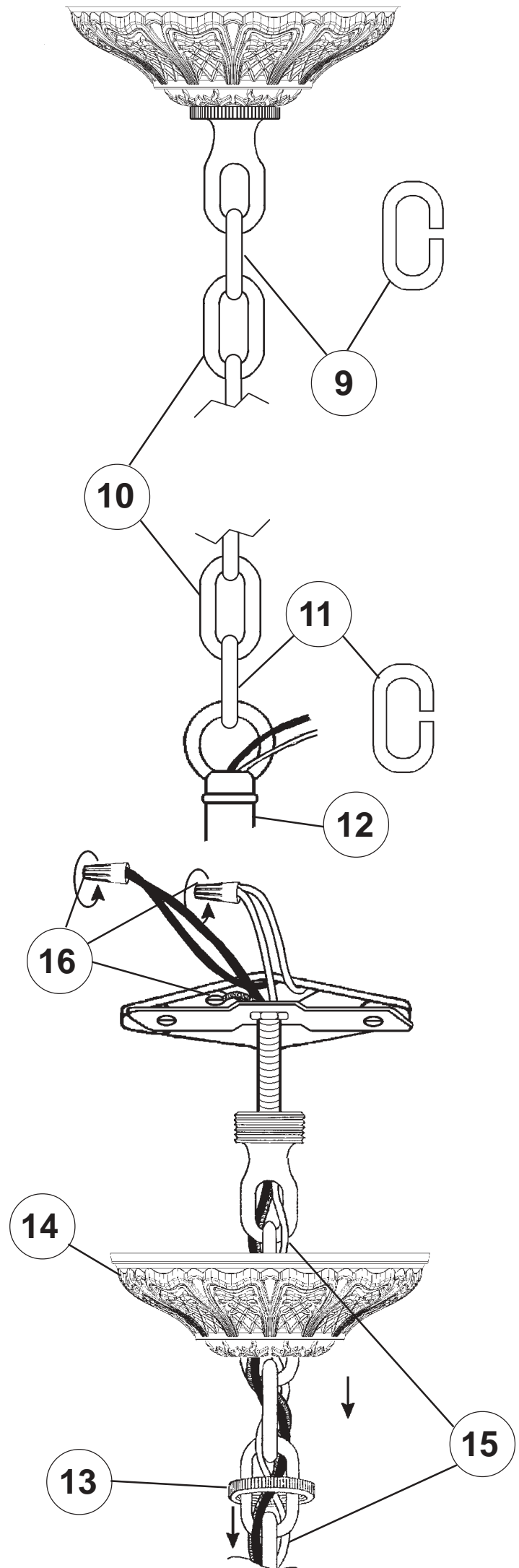
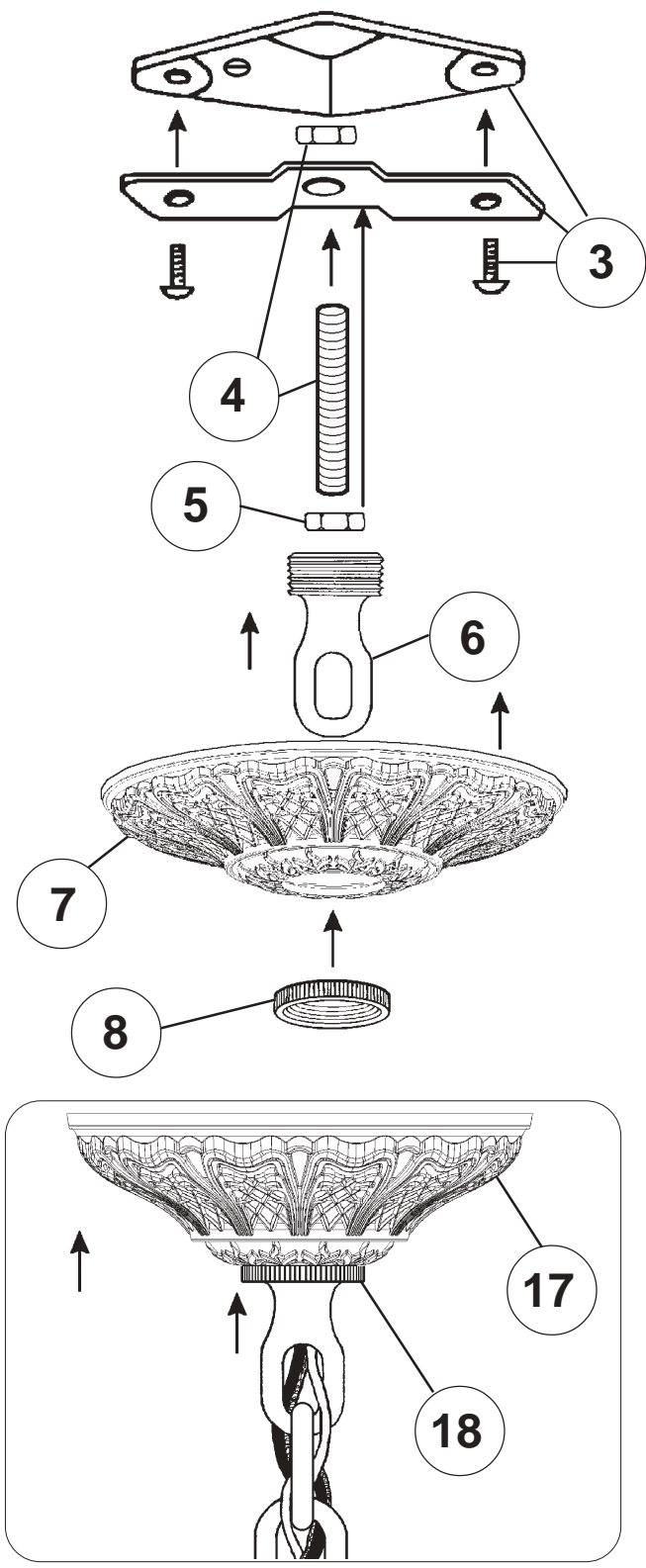

**CHANDELIER 5683- \_\_\_\_\_ TRIM DIAGRAM**

(Finish Option) (Trim Option)

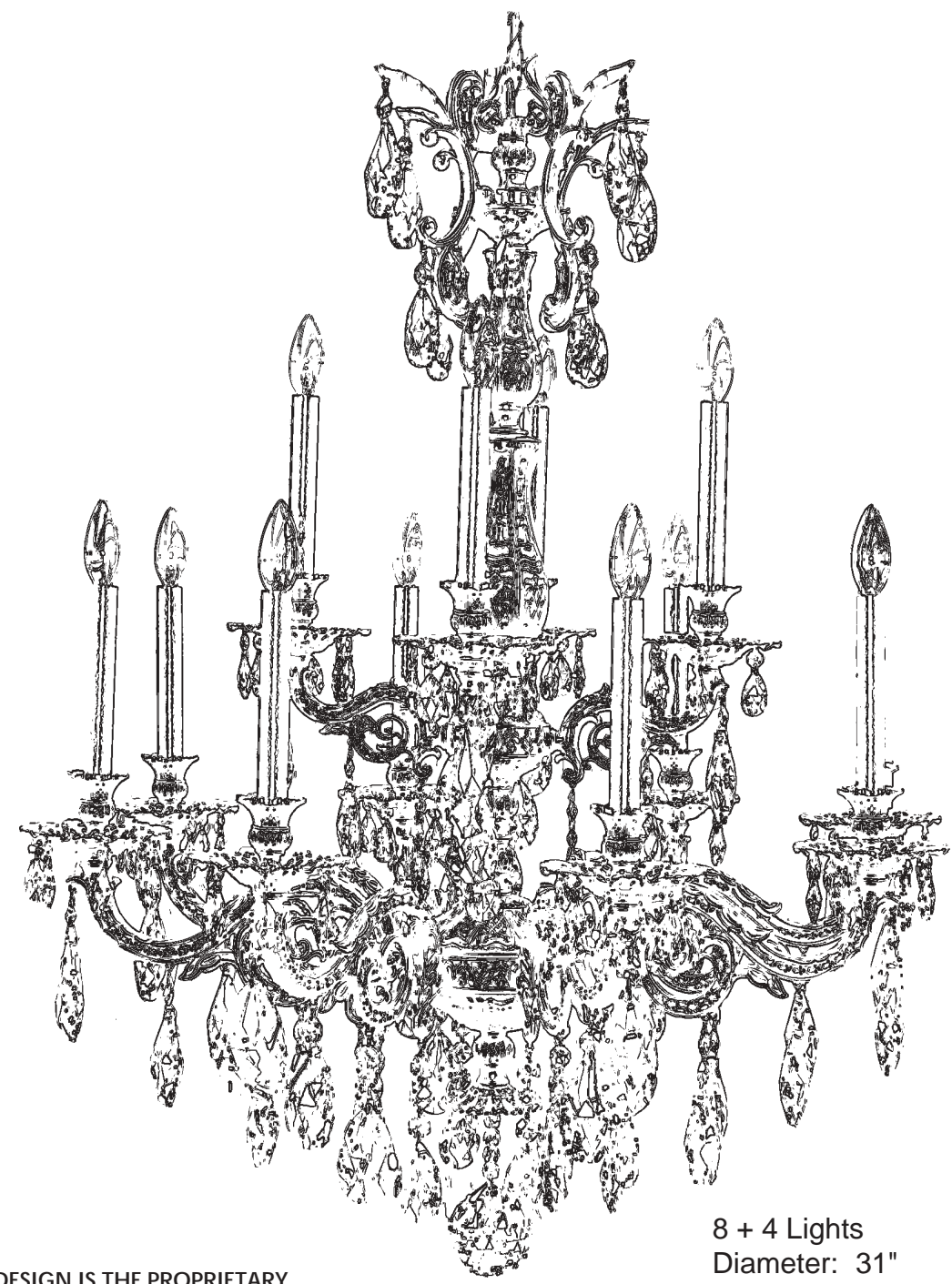

8 + 4 Lights  
Diameter: 31"  
Body Length: 40"  
Hanging Weight: 32 lbs.

**T**HIS DESIGN IS THE PROPRIETARY TRADE DRESS/TRADEMARK OF SCHONBEK WORLDWIDE LIGHTING INC.

**SCHONBEK®**

**See diagram on back page**  
**Follow steps in exact order**  
**Save this trim diagram for future reference**

**1** **IMPORTANT**  
*Person who opens carton should record the following information for future service.*

CODE # \_\_\_\_\_ Four-digit number on outside of carton.  
PACKER # \_\_\_\_\_ See crystal package label.  
ORDER # \_\_\_\_\_ See crystal package label.



# Instructions for crystal trimming

## STEPS 19 - 33

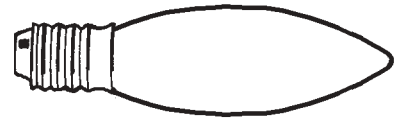

You will need 12 - C10  
25 Watts Recommended  
60 Watts Max

19

Install bulbs and be  
sure to test fixture  
BEFORE trimming.

### DIAGRAM #1

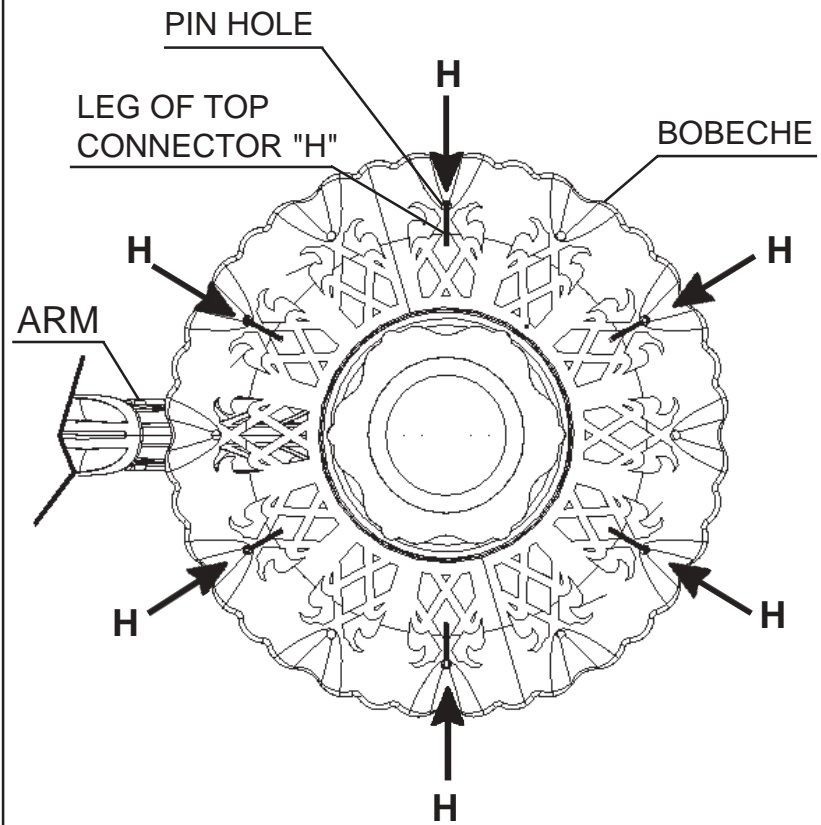

When trimming bobèche with letter "H", insert leg of top connector into pin hole from under bobèche. Hang in every other pin hole starting on either side of the arm (refer to Diagram #1)

