

SCHONBEK

1870

NOUVEAU HAMILTON HA5808N- __ __ H

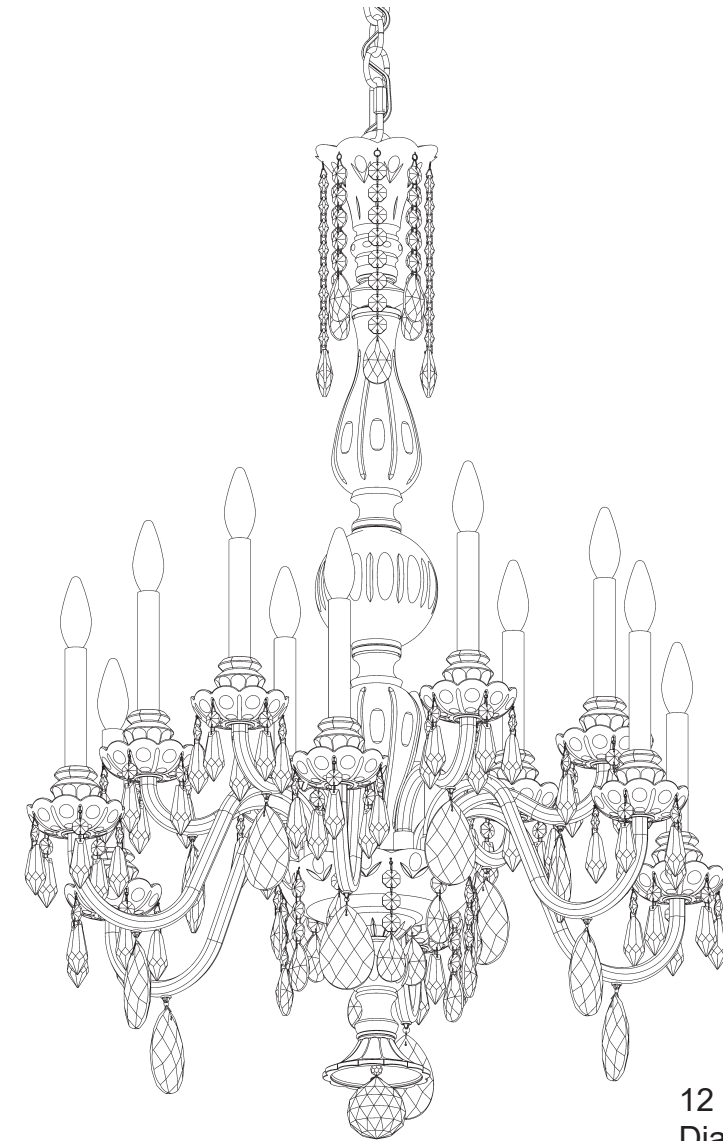

THIS DESIGN IS THE PROPRIETARY TRADE DRESS/TRADEMARK OF SWAROVSKI LIGHTING, LTD.

12 Lights
Diameter: 30"
Body Length: 44"
Hanging Weight: 41lbs.

SCHONBEK

1870

MAX <u>60</u> W	110-120 V							

SCHONBEK® is a member of the Swarovski group.

All electrical components must be installed by a licensed electrician in accordance with the National Electric Code and the appropriate local electrical codes.

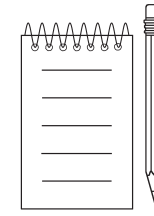
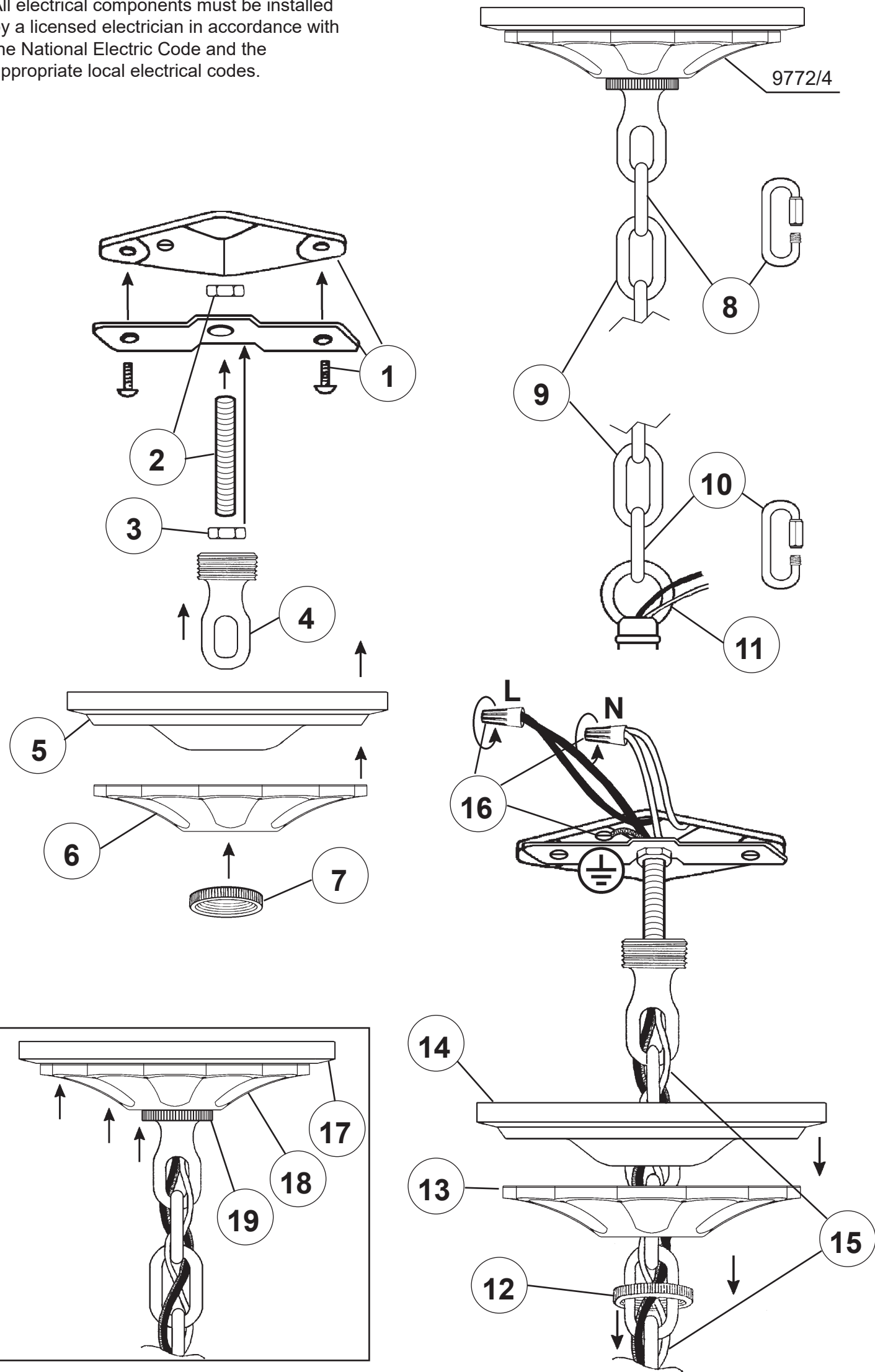

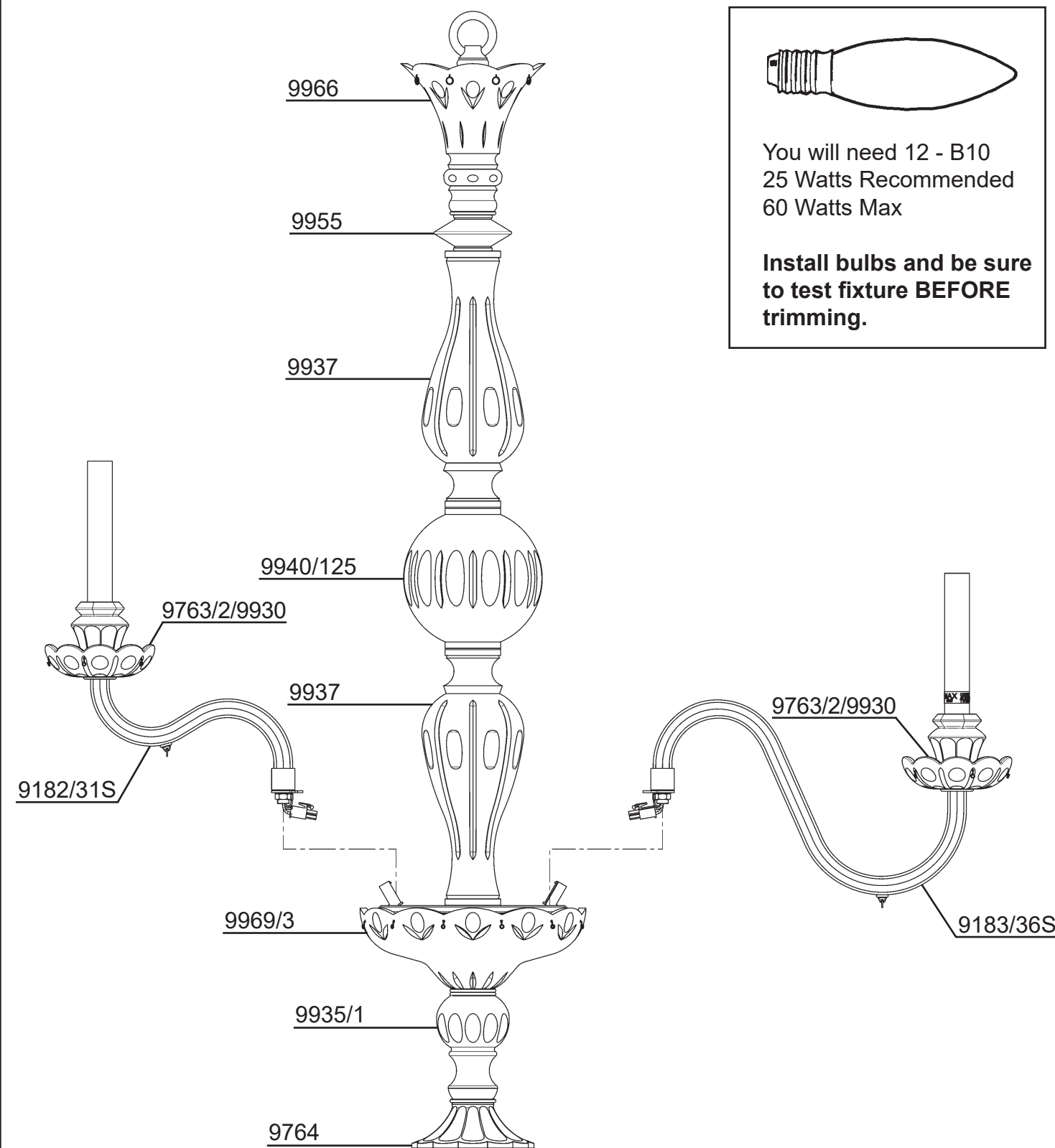
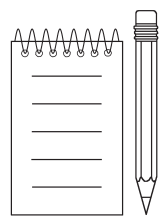

20 Connect arm wires using plug-in connectors. See detailed illustration.

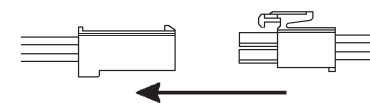

21 Push wires into hole and attach arm to washer by rotating arm into place. Lock down by tightening screws into flange. See detailed illustration.

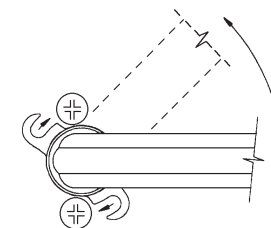

22 Install bobèche on every arm and screw bulbs into all sockets. Connect power and test fixture before trimming. If any of the bulbs do NOT light - DISCONNECT POWER. Double check the wire connections.

ALTERNATE HANGING
LETTERS "A" AND "B"

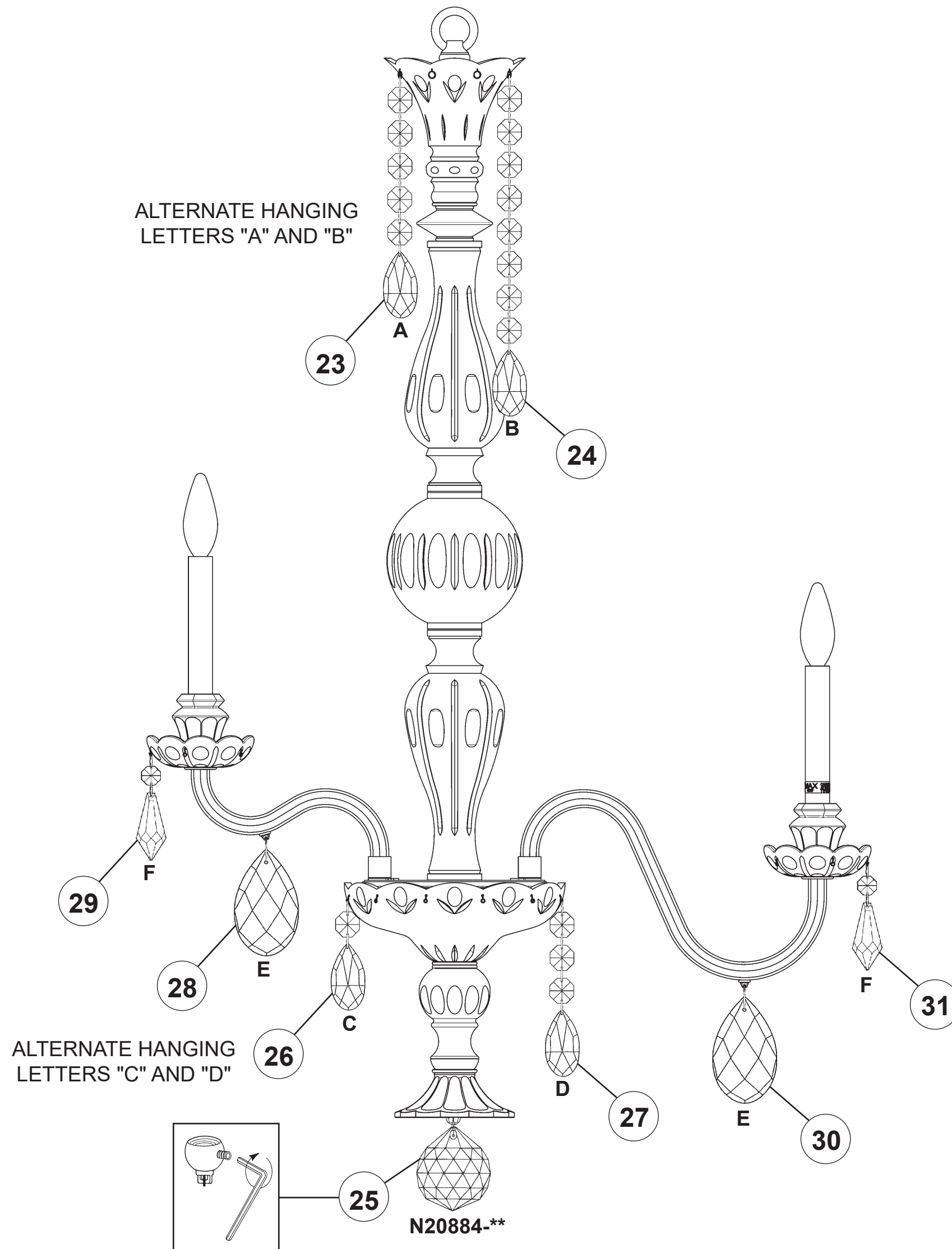

ALTERNATE HANGING
LETTERS "C" AND "D"

