

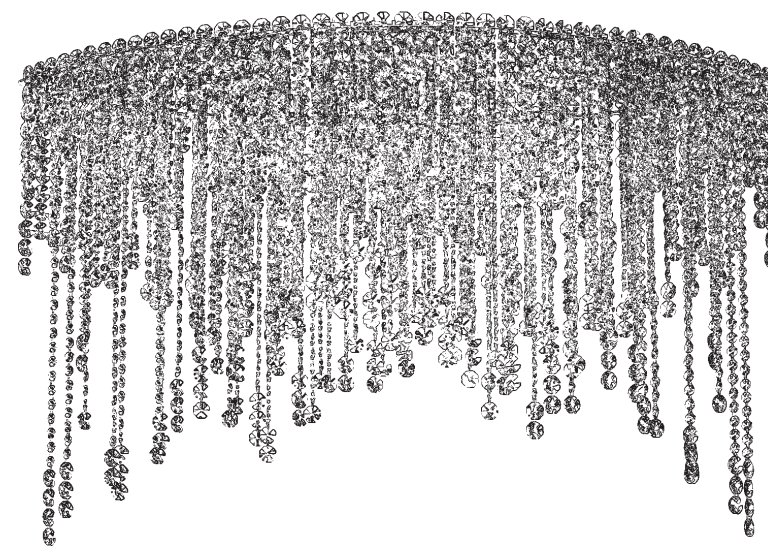

SCHONBEK®

CHANTANT
CH4802N- __ _ H



THIS DESIGN IS THE PROPRIETARY
TRADE DRESS/TRADE MARK OF
SWAROVSKI LIGHTING, LTD.

8 Lights
Height: 27-1/2"
Length: 43"
Width: 22"
Hanging Weight: 49lbs.



SCHONBEK®

MAX 35 W		110-120 V						

NOTE: INSTALLER IS SOLELY RESPONSIBLE FOR PROPER MOUNTING!

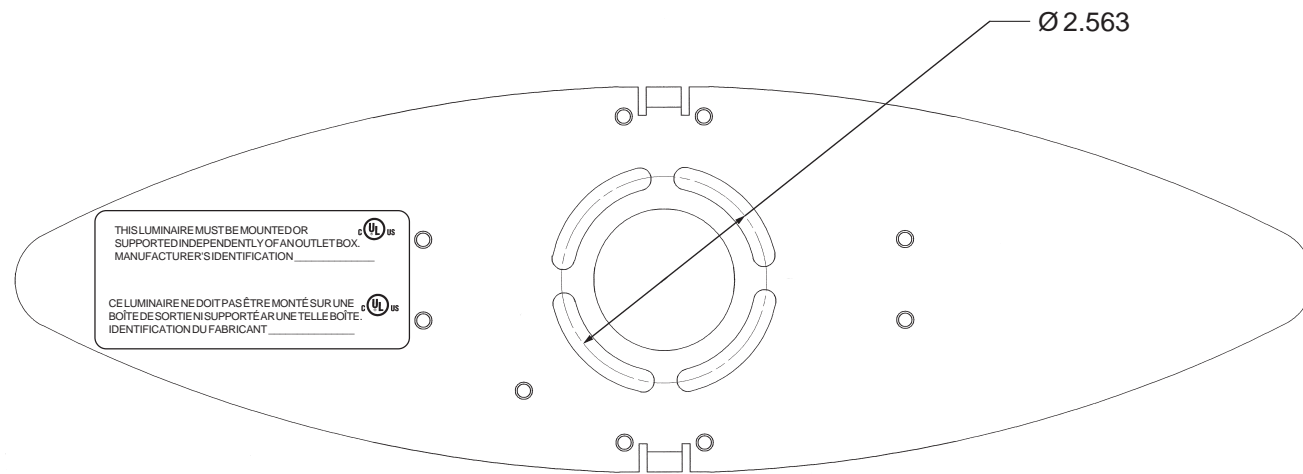

PLAN VIEW OF MOUNTING BRACKET

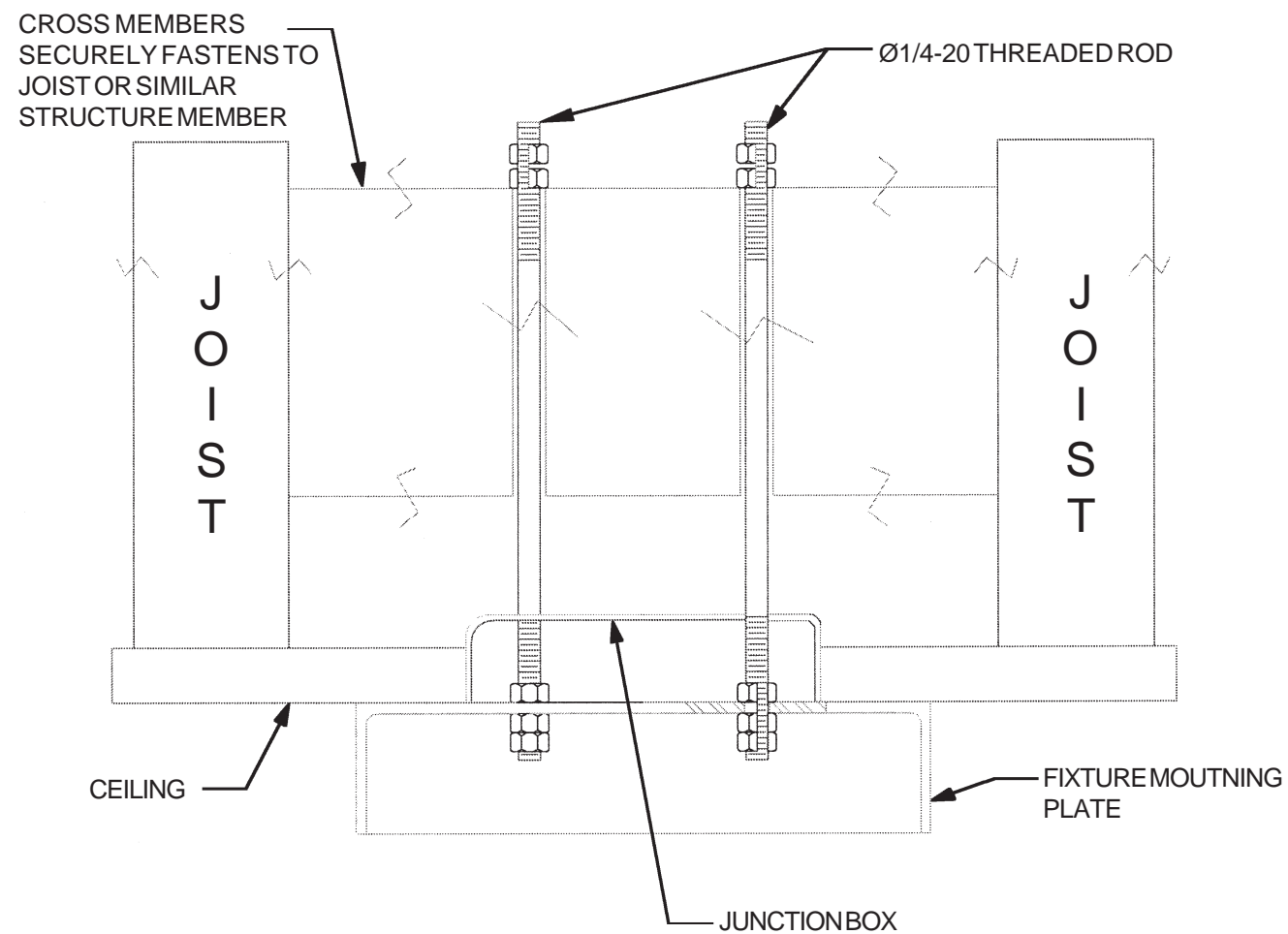



WARNING:
MOUNTING CONFIGURATION AND HARDWARE MUST HOLD 4X THE WEIGHT OF THE FIXTURE. MOUNTING DESIGN AND FIXTURE INSTALLATION SHOULD BE CONDUCTED BY A QUALIFIED LICENSED PROFESSIONAL.

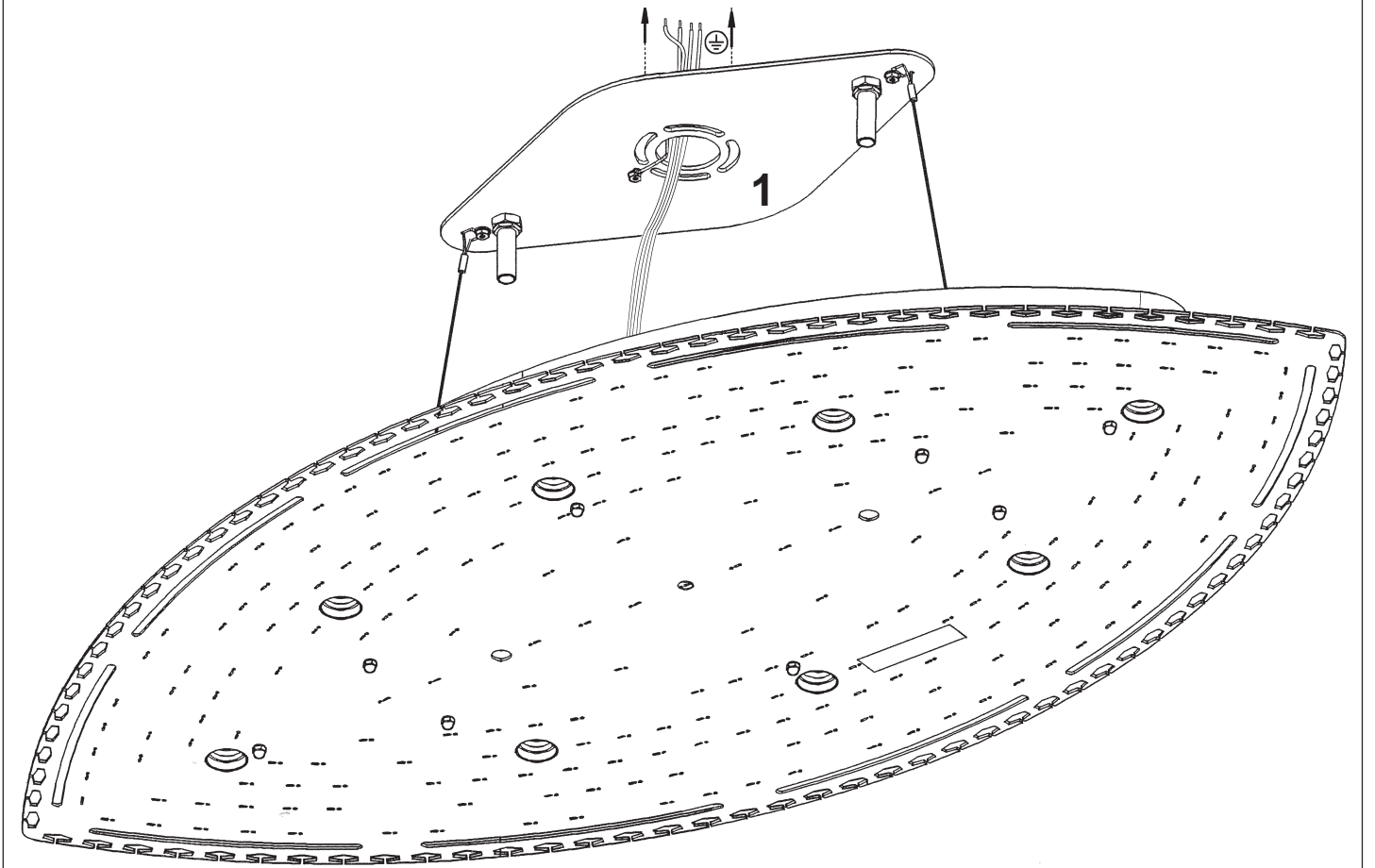
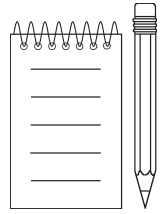

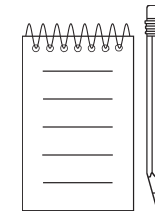
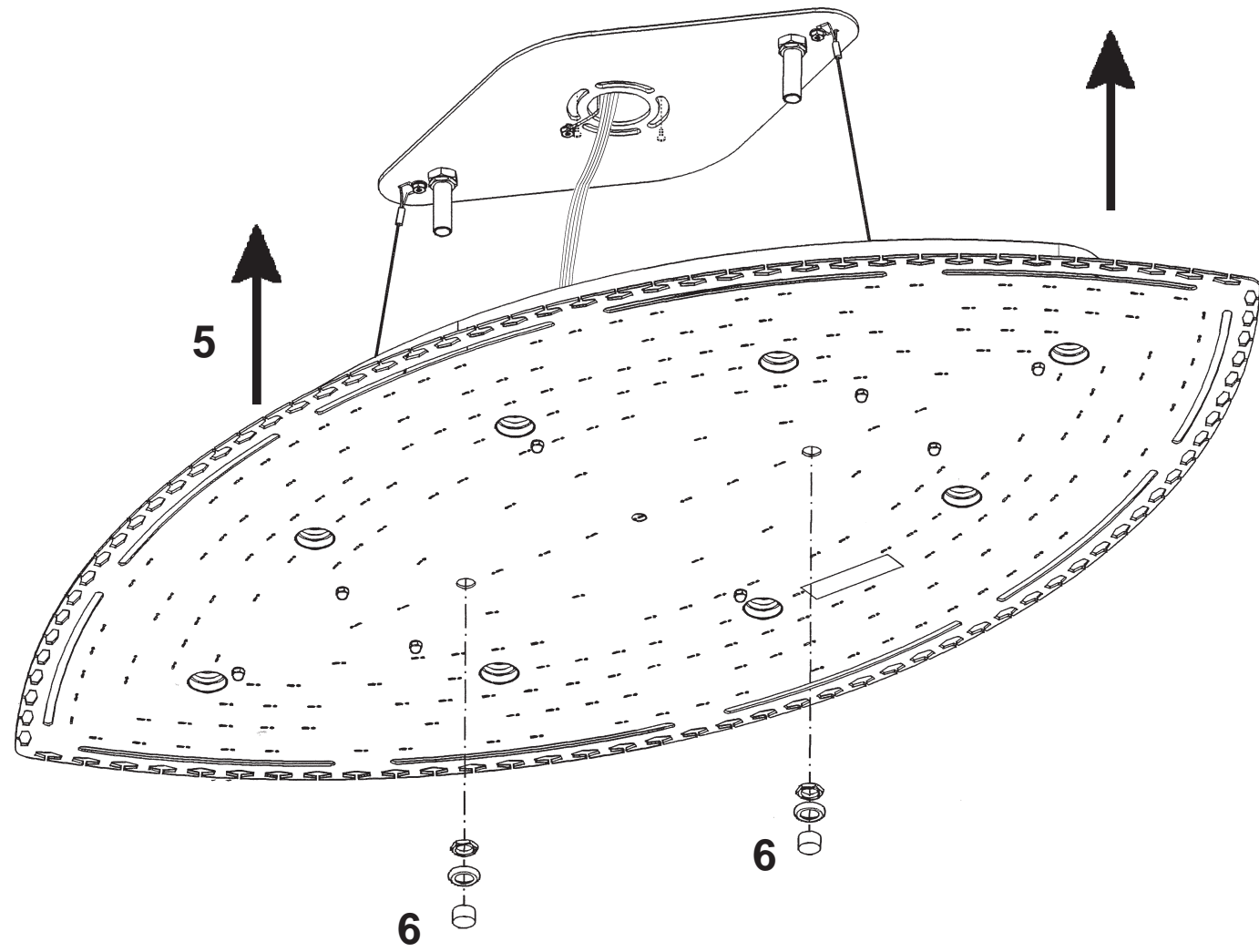
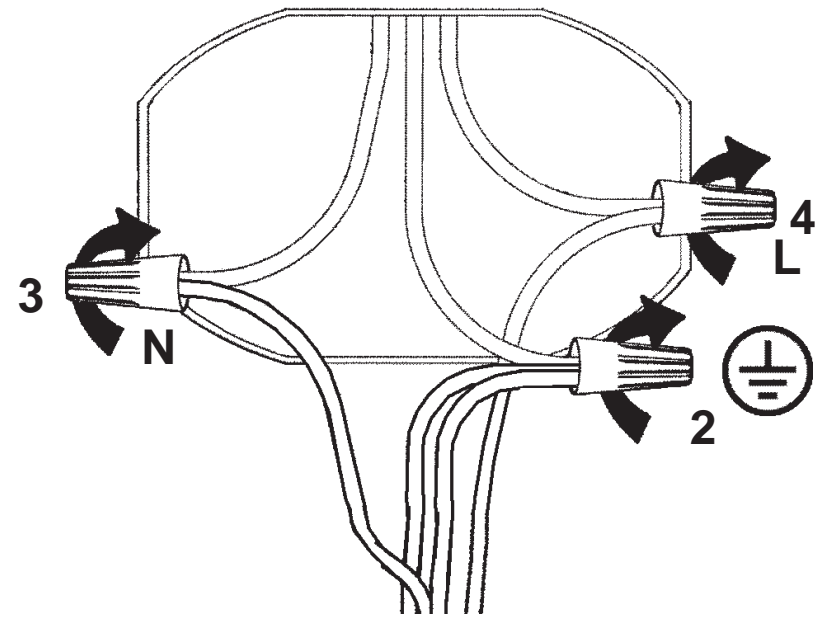

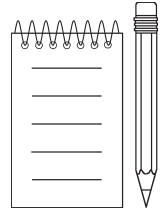

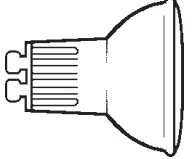

8 X  : GU10 35W MAX 

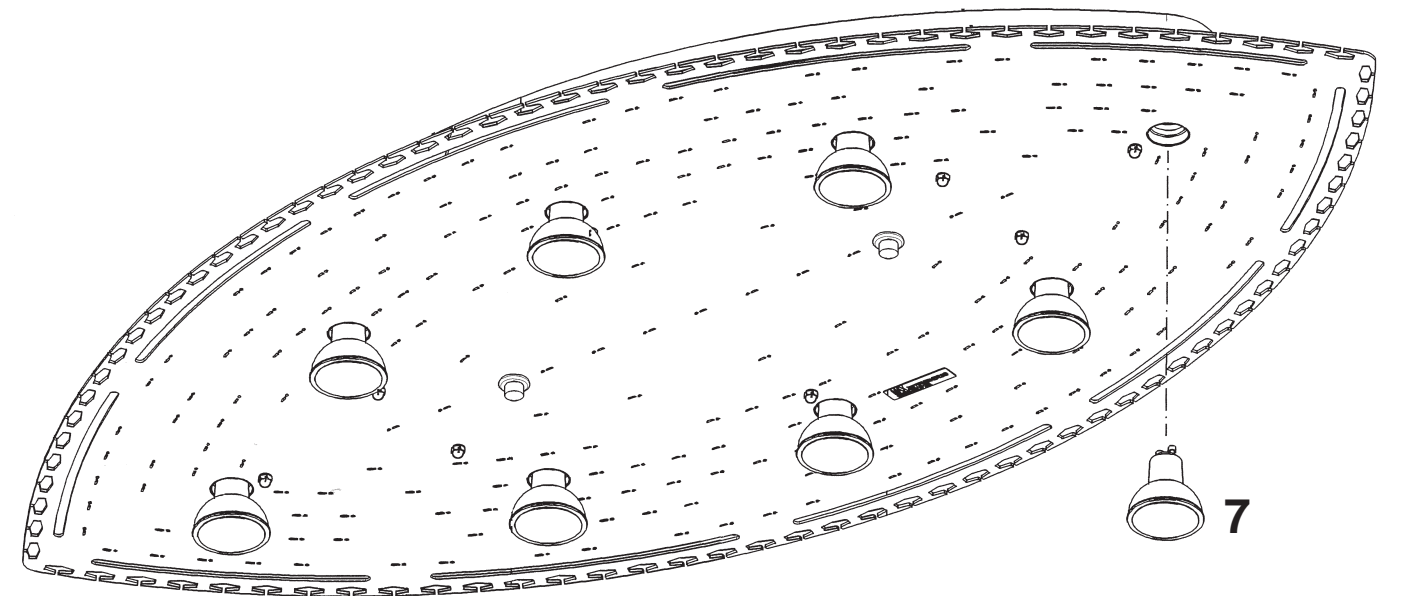

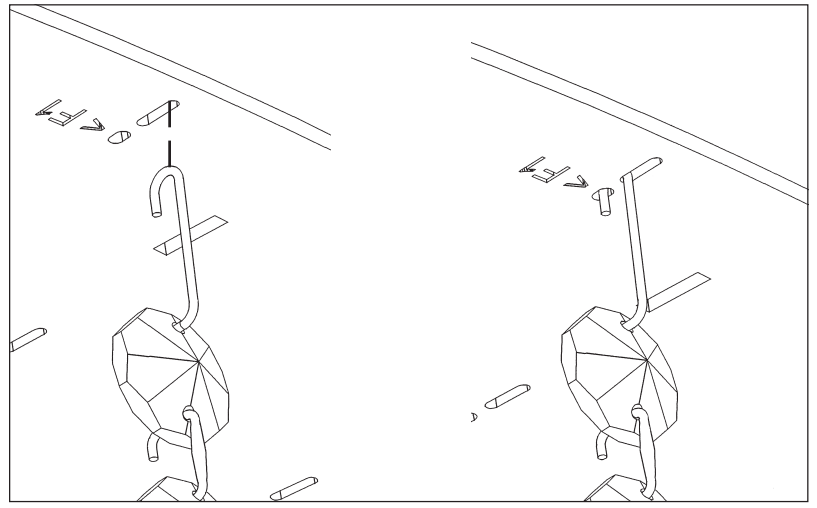
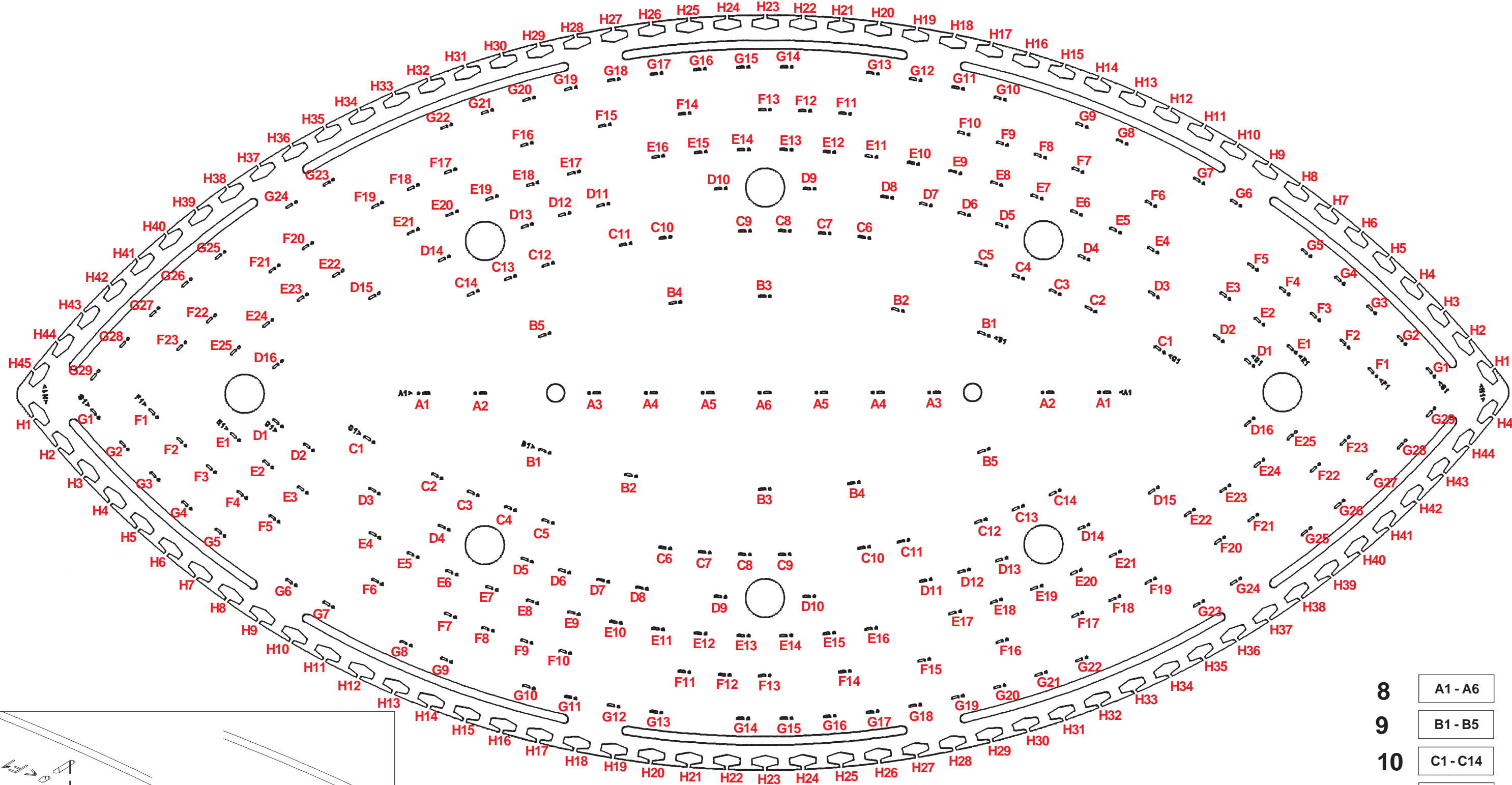

After hanging all trim, remove labels from crystals. If residue remains, wipe off crystal with a soft, dry cloth.

- 8** A1 - A6
- 9** B1 - B5
- 10** C1 - C14
- 11** D1 - D16
- 12** E1 - E25
- 13** F1 - F23
- 14** G1 - G29
- 15** H1 - H45