

**T**HIS DESIGN IS THE PROPRIETARY TRADE DRESS/TRADEMARK OF SWAROVSKI LIGHTING, LTD.

12 Lights  
Diameter: 32"  
Body Length: 38"  
Hanging Weight: 46 lbs.

# SCHONBEK

1870

# SCHONBEK

1870

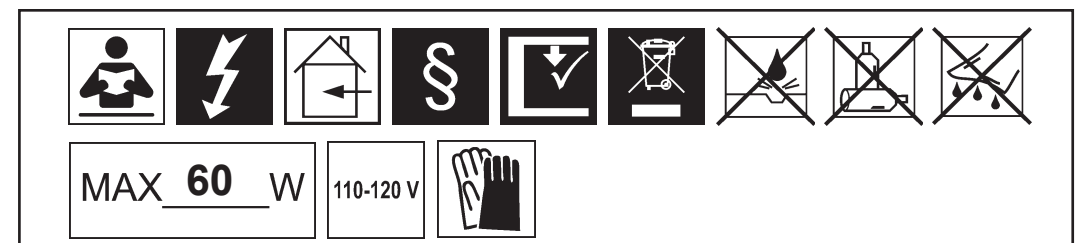

All electrical components must be installed by a licensed electrician in accordance with the National Electric Code and the appropriate local electrical codes.

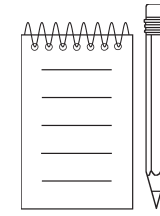
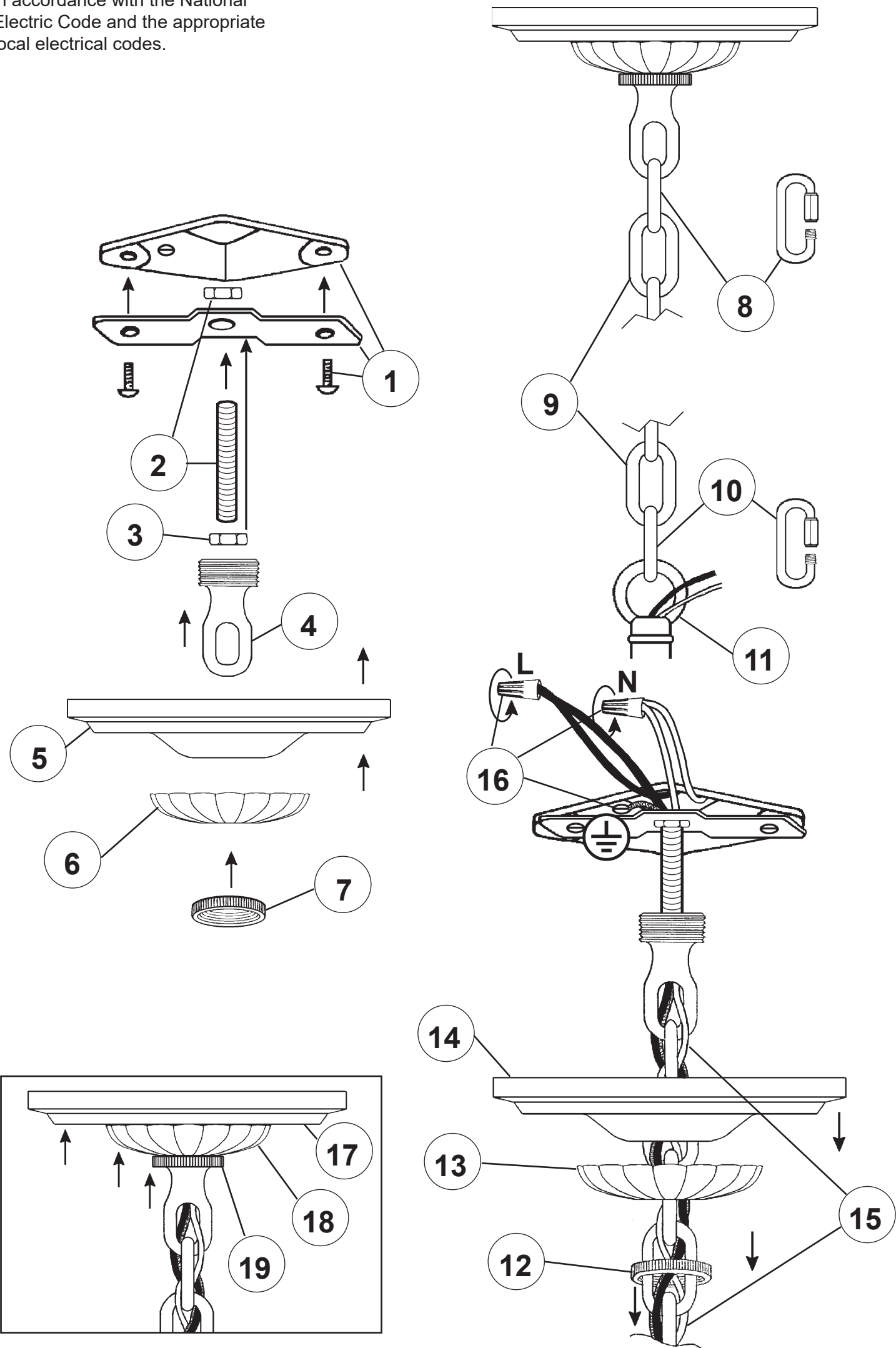

**Crystal Set 3 in Black**

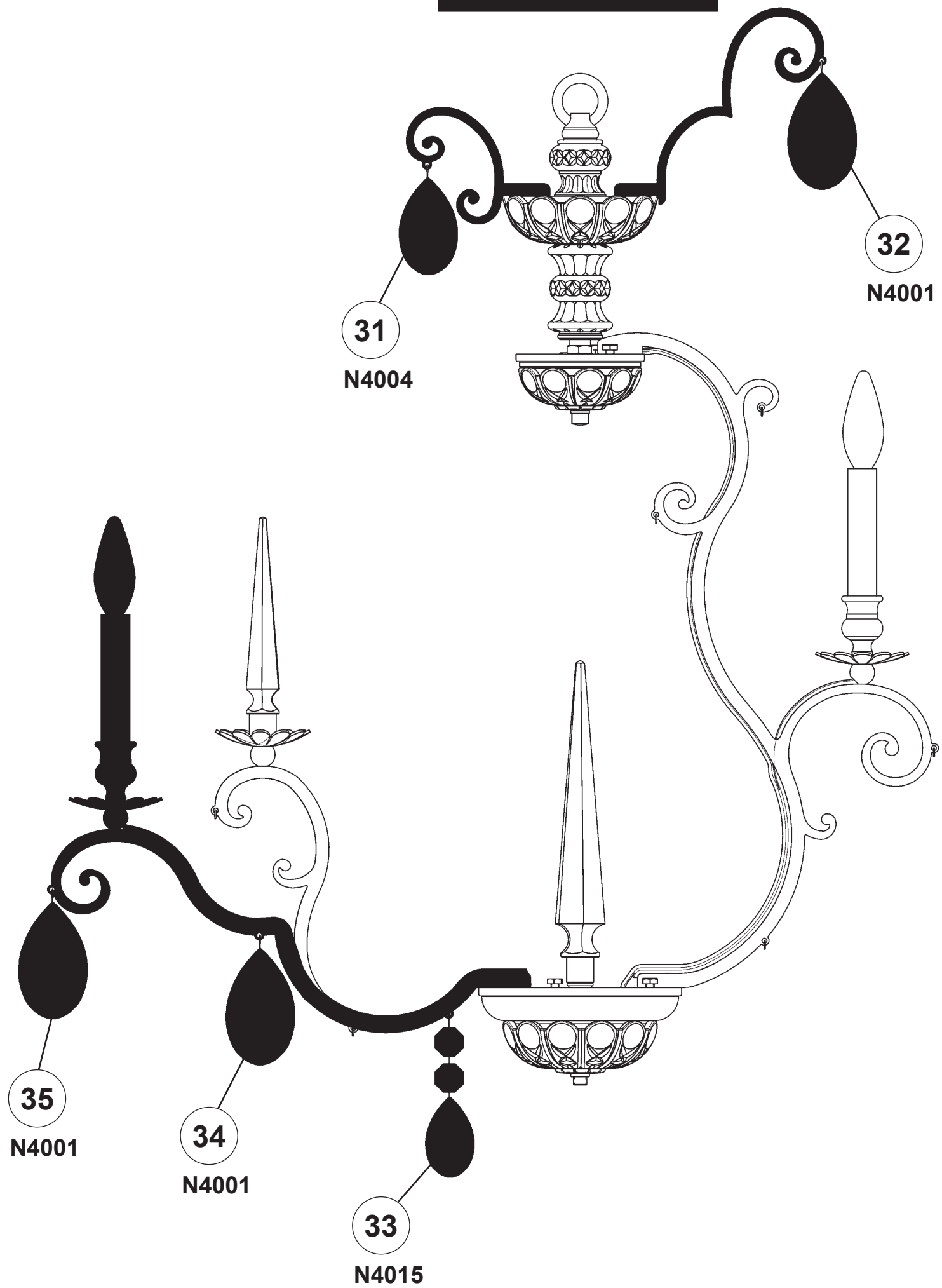

**SET 1**

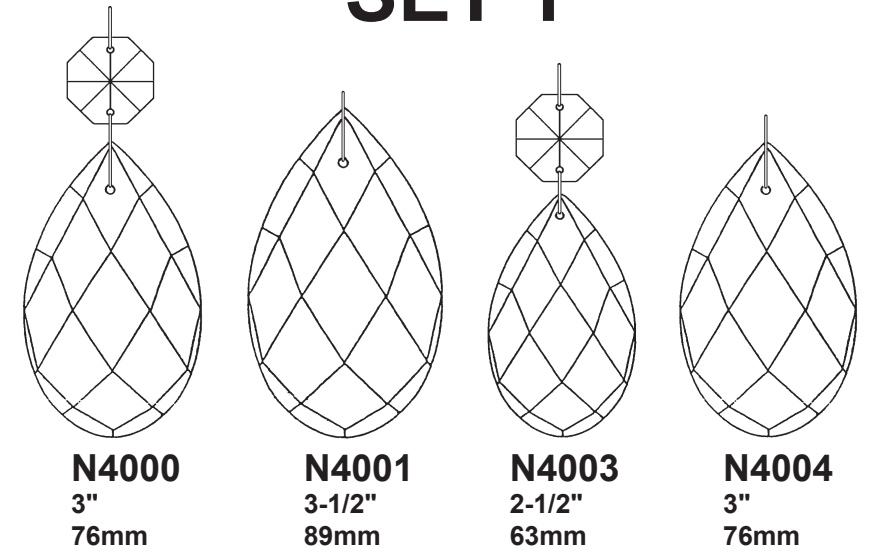

**SET 2**



**SET 3**

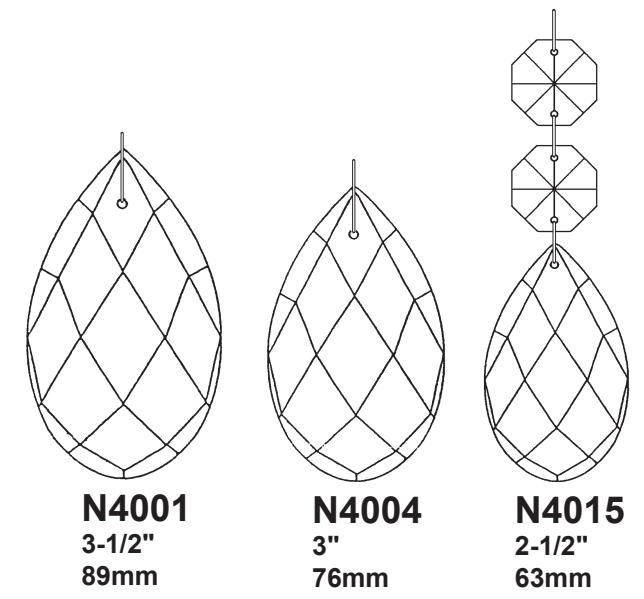

20



You will need 12 - B10  
25 Watts Recommended  
60 Watts Max

Install bulbs and be sure  
to test fixture BEFORE  
trimming.

1 X : 400/16-\*\*

Crystal Set 1 in Black

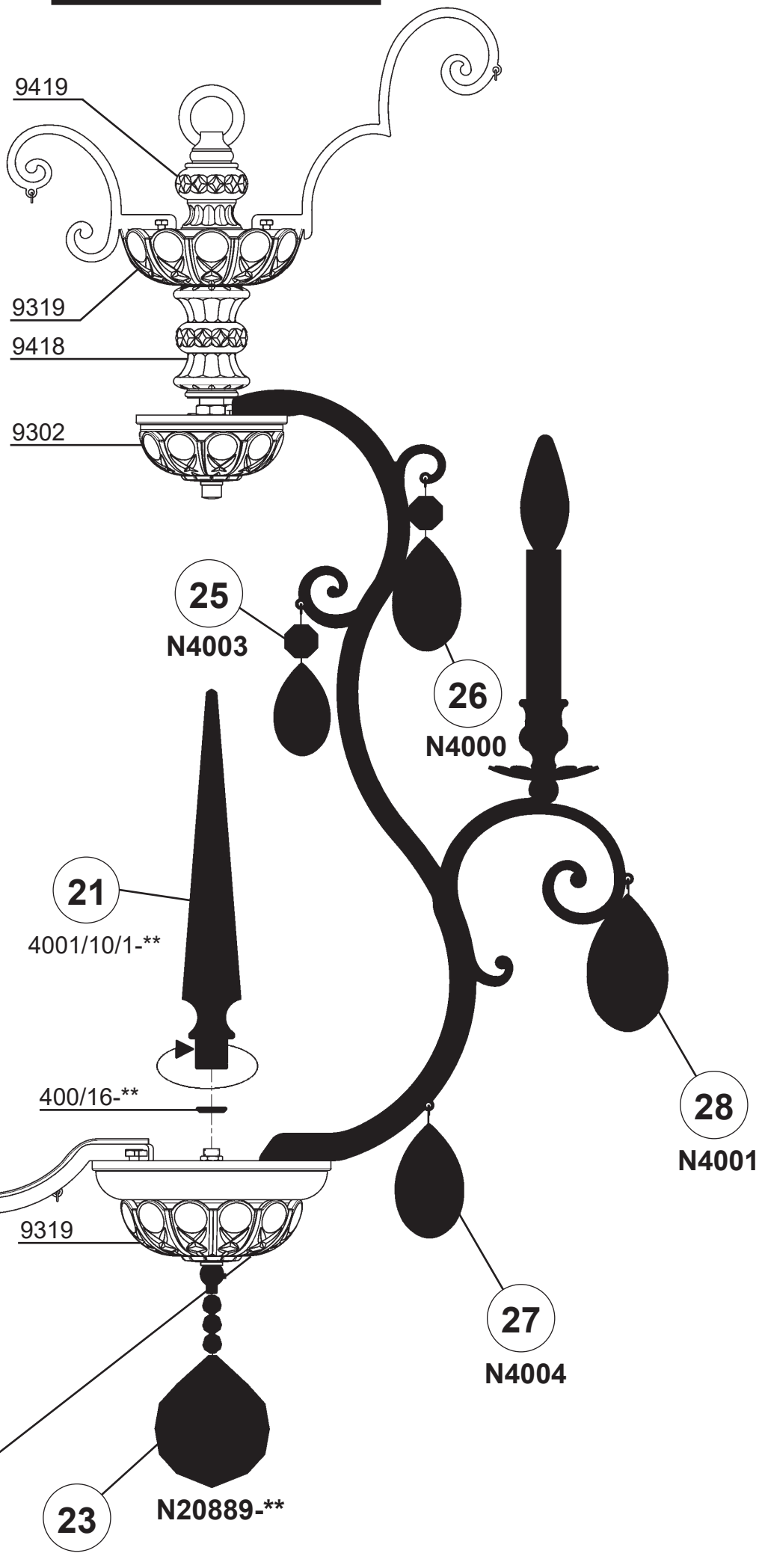

Crystal Set 2 in Black

