

my
SCHONBEK
1870

2020

Collection

SCHONBEK

1870

We make lighting that lives forever.

Rooted in the American craftsmanship tradition since 1870, Schonbek makes timeless lighting with an impact that lasts.

For more than a century, our designs have sparked conversation and brought people together. Light brings life to a home – and life is what Schonbek is all about. When families gather for Sunday dinner, new friends are made, lovers meet, and memories are created; Schonbek is part of every moment that makes life rich.

Our story began when young Adolph Schonbek left his grandfather's glassworks to pursue his dream of making custom chandeliers with the finest crystal. Since then, Schonbek has grown into a world-renowned premium lighting brand, captivating consumers across generations and continents with its timeless designs.

Our styles reflect the dynamic aesthetic tradition of America. Ranging from classically elegant to contemporary cool, our fixtures are characterized by their warm and inviting shapes and close attention to detail.

We are driven by a passion for lighting that makes spaces come alive and have a love for perfectly balanced pieces of beauty and function. We make styles to talk about with details to remember, icons to treasure, carry through life and pass on to the next generation.

Wherever it is placed, a Schonbek piece fills the home with personality and elegance that transcends time.

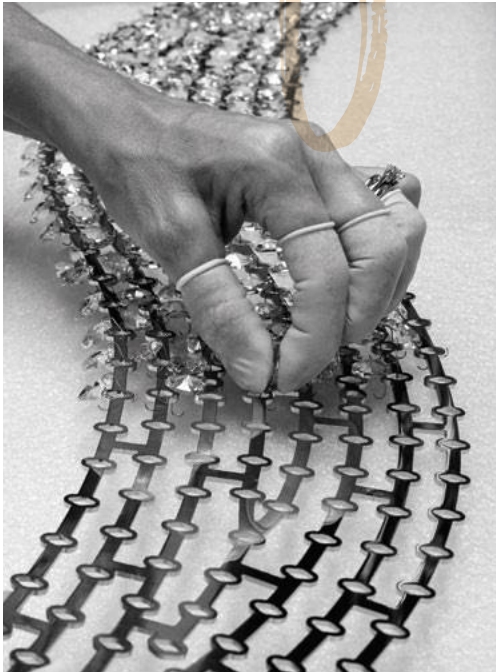

forever

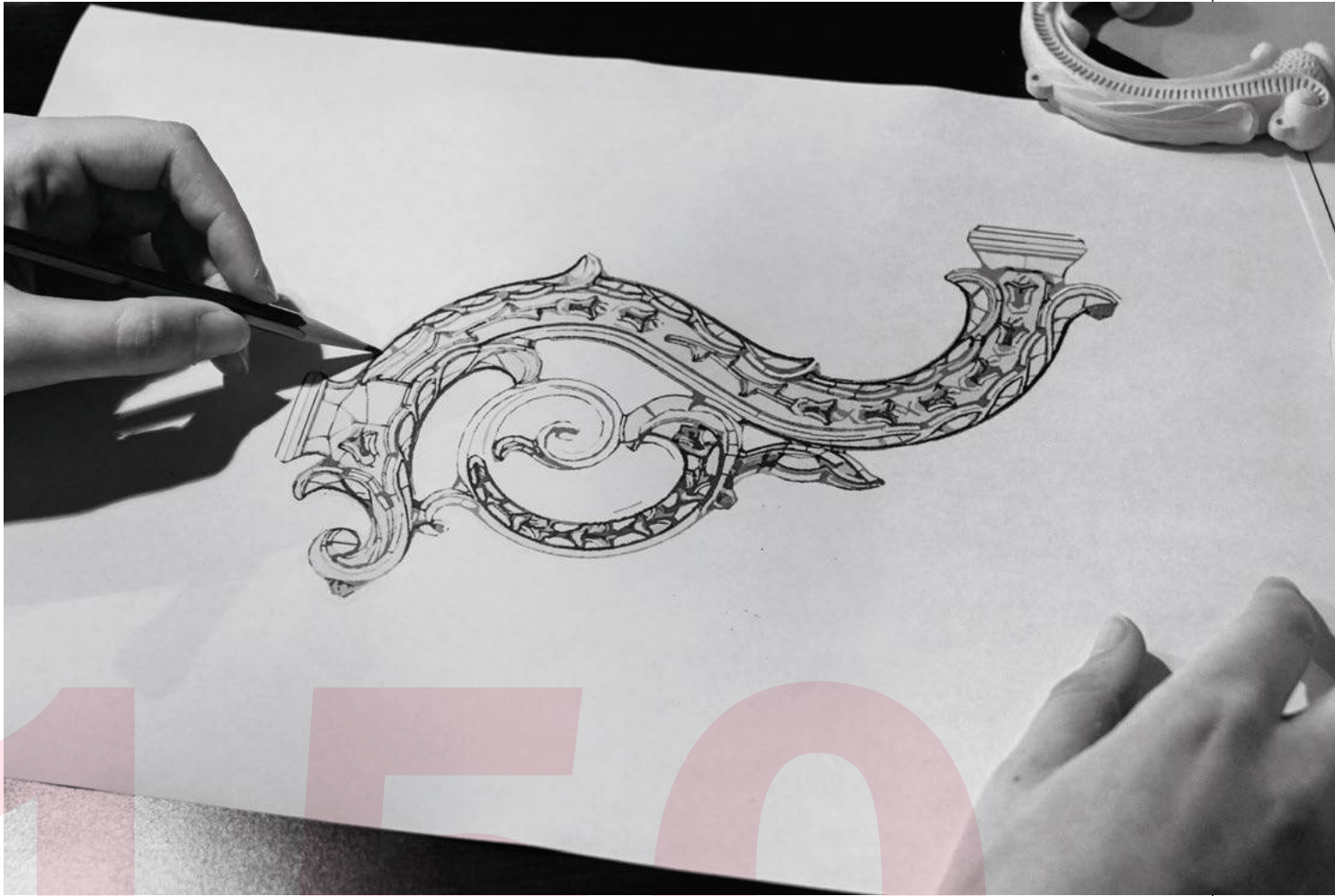

150

150 Years of American Craftsmanship

In 2020, we celebrate 150 years of Schonbek lighting. The passion for innovation and commitment to beauty in every detail that has made Schonbek a world-renowned lighting brand over the past 150 years continues to drive us forward today. Rooted in the heritage of American craftsmanship, we constantly explore new ways to transform spaces with light, always with our century-long promise at heart: to make lighting that lives forever.

True American Heritage

Schonbek is part of the American history and shares the attributes of other classic American brands. Rather than a desire to set trends, we have a deep and abiding respect for the people who are going to live with our products in their homes. Schonbek stands for warmth and generosity, and the joy of bringing family and friends together. We strive to create spaces where light is as much about atmosphere and ambience as it is about functionality.



A Pioneering Spirit

While building on tradition and experience, Schonbek constantly moves borders. We use proven technologies in innovative ways to continuously evolve the art of lighting. We use innovation by combination, in everything from raw materials to design, to push the boundaries of what a classic piece can bring to elevate the experience of any home.



pioneer

Wow

A Sense of Wow

When you walk into a room with a Schonbek piece, you have something to talk about. A Schonbek fixture flatters and empowers every space. It is a conversation piece that awakens curiosity and a desire to learn more.



What we Believe In

timeless

Timeless Beauty

Schonbek products are instantly recognizable by their iconic silhouettes. We prioritize longevity and a strong appeal that endures. Our legacy was not built by standing still. Schonbek is never antique, nor do we look backwards. Our aim is to create products that are loved across generations and carried through life as treasures.



True Craftsmanship

The luxury of a Schonbek piece ultimately comes from being crafted by qualified artisans. From design to functionality and use of materials, everything we do is made to last. We are proud of retaining and passing down the distinct know-how that makes a Schonbek product so precious.



Craft

Commitment to Authenticity

Since 1870, Schonbek has been synonymous with authentic chandeliers and designs of the highest heirloom quality. In a world seeking sincerity and lasting appeal, consumers can always trust Schonbek for representing true value. We are committed to that mission and dedicated to honest conversations about our products.



American Traditional

Page 14 – 227

1

Product Line **New Orleans**
Page **104 – 111**



American Romantic

Page 228 – 269

2

Product Line **Tassau**
Page **262 – 269**

Our Main Collections

Schonbek lighting is offered in four distinctive collections, all grounded in a sense of classicism and crafted with the greatest attention to quality and detail. Their styles – American Traditional, American Romantic, American Rustic, and American Contemporary – complement a range of architectural and interior designs. Most importantly, Schonbek’s collections enhance the creation of spaces that express the unique spirit of those who call them home. Spaces for the celebration of life’s grandest occasions as well as its most cherished private moments.

3

American Rustic

Page 270 – 301



Product Line **Emilea**
Page **280 – 285**

Product Line **Chatter**
Page **344 – 347**



American Contemporary

Page 302 – 427

4

New Products 2020

With beautifully detailed glass arms, exquisitely faceted large crystals in various shapes, and elongated candle slips, Savannah celebrates the timeless romance of the chandelier. Wall sconces express the same elegance with a single long tiered crystal pendant balancing the height of the candle slip. Savannah always complements her hostess, elevating the tenor of traditional, contemporary, and eclectic interiors.



Collection **American Traditional**
Product Line **Savannah**
Page **180 – 183**

Glamorous and fluid yet also tailored and geometrically precise, Southampton is traditional elegance with a twist. Crystal-beaded chains suspended from a halo of slim metal tubing create a symmetrical curtain. A cluster of seeded glass globes of varying sizes is set at the midpoint between the halo and the curtain. Light refracted through Southampton's crystals has a lively quality that feels particularly apt for social spaces like living and dining rooms.

New Products 2020

Collection **American Traditional**
Product Line **Southampton**
Page **194 – 197**

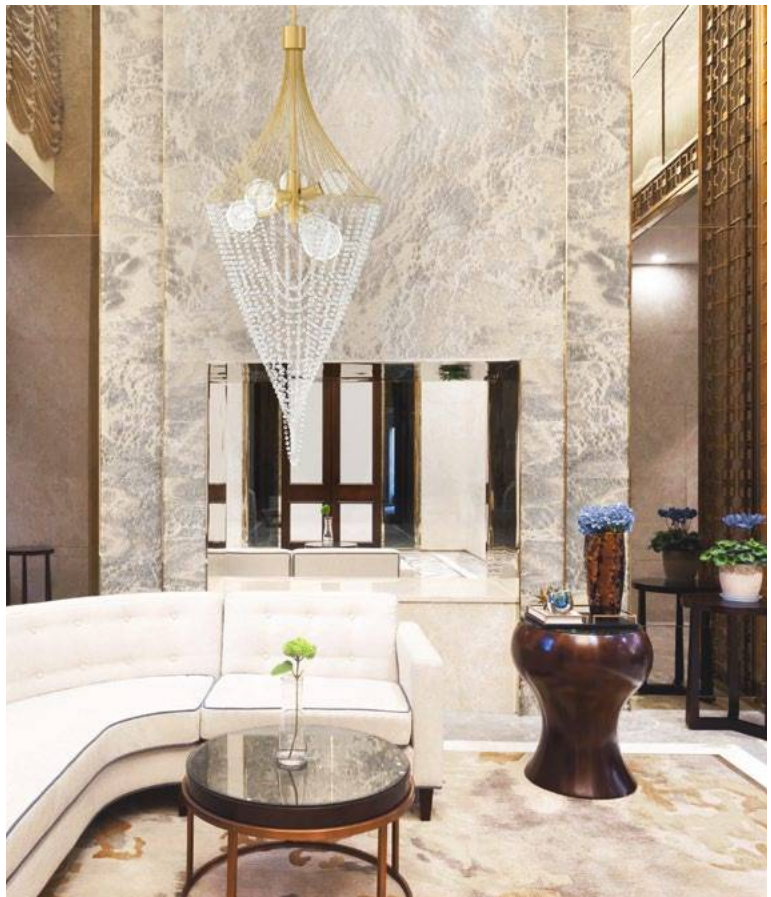



Asheville is inspired by the simple geometries and organic forms that have maintained eternal appeal from pre-history to present-day. Large and small pendants are unabashedly contemporary yet would make a brilliant counterpoint within a traditional interior. Open metal circles set on a rod are movable around a cluster of seeded glass globes and the shape of the fixtures appears different from various perspectives.

Collection **American Contemporary**
Product Line **Asheville**
Page **314 – 317**

New



Collection **American Contemporary**
Product Line **SoHo**
Page **406 – 411**

Inspired by the image of birds perched along a power line and designed with the ability to adapt to a variety of interior scenarios, SoHo fixtures have an airy, sculptural presence. The arms of the pendants can be aligned or can be set at angles to make a more dramatic statement. With faceted shades oriented up, SoHo pendants provide ambient illumination that is ideal for dining or entertainment spaces, and when shades are oriented down, the pendants work well for areas, like kitchens, that benefit from task-style lighting. Similarly, wall sconces are easily arranged in pairs with faceted shades oriented to deliver directional lighting as desired.

Ne

Named for an enchanting getaway spot off the coast of Georgia, Talahi fixtures combine simple elegance with delightful details. The arms of the chandeliers are inspired by the arc of stems in a bouquet of freshly cut flowers with heavy blooms. Talahi's wall sconces and ceiling-mounted fixtures reinterpret the patterns of lace doilies in decorative metalwork. Petite crystals add delicate touches of sparkle that catch the eye.

EW



Collection **American Romantic**
 Product Line **Talahi**
 Page **258 – 261**

Collection **American Romantic**
 Product Line **St. Simons**
 Page **254 – 257**

With slender unadorned arms, tall candles and long teardrop crystal pendants, St. Simons chandeliers bring a light feminine touch to the spaces they illuminate. Like a prima ballerina, St. Simons appears delicate, but has impeccable poise and remarkable presence. It is easy to imagine a member of the St. Simons line of chandeliers adding a romantic note to a contemporary living room or contributing to a gracious welcome in the foyer of a classical home.

Inspired by history, culture, and the natural world, Schonbek's American Traditional Collection is richly detailed and often ornate. Decorative elements speak to Schonbek's heritage of craftsmanship and may recall the extravagant gestures of neo-Baroque architecture or the delicate textures and patterns of a formal garden. With sensitivity to the timeless aspects of art and nature, pieces from this collection can easily join family heirlooms in classical homes or serve as standout statement pieces in modern or eclectic interiors.



1

American Trad



ditional

Overview



Arlington
18 – 23



Da Vinci
58 – 63



Milano
94 – 103



Bagatelle
24 – 31



Equinoxe
64 – 69



New Orleans
104 – 111



Bordeaux
32 – 37



Filigrae
70 – 75



Novielle
112 – 115



Camelot
38 – 34



Hamilton
76 – 81



Olde World
116 – 123



Century
44 – 51



**Hamilton
Rock
Crystal**
82 – 85



Petit Crystal
124 – 127



Chrysalita
52 – 57



La Scala
86 – 93



**Petit Crystal
Deluxe**
128 – 135



Plaza
136 – 143



Sonatina
184 – 189



Trilliane
216 – 227



Renaissance
144 – 153



Sophia
190 – 193



**Renaissance
Rock Crystal**
158 – 163



Southampton
194 – 197

NEW



Rivendell
154 – 160

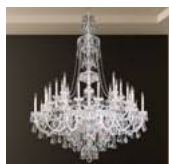

Sterling
198 – 205



Sarella
166 – 179



Tiara
206 – 209



Savannah
180 – 183

NEW



Triandra
210 – 215

Arlington

Transporting you to the dramatic, contemplative mood of the Romantic era, Arlington is an all-crystal chandelier with elaborately cut crystal column pieces, dishes, and bobeches. In a grand home filled with antiques, paintings and tapestries, Arlington makes a striking statement.

* Product only available in 110V

Crystal Options



Heritage Crystal
(H)

Finish Options















Polished Silver
(-40)







Chandelier		1310	
 (H)	 (-40)		
 55 lbs / 24.8 kg	 -		

 44.5 in / 113 cm	 25-B10 60max
 64 in / 163 cm	 110 -
 -	 220 -
 84 in / 213 cm	 220 -
 210 in / 533 cm	AVL 110V



Chandelier		1308	
	(H)		(-40)
	30 lbs / 13.5 kg		-
	32 in / 81 cm		15-B10 60max
	48 in / 122 cm		-
	-		-
	40 in / 102 cm		-
	150 in / 381 cm	AVL	110V



Chandelier		1305	
	(H)		(-40)
	16 lbs / 7.2 kg		-
	28 in / 71 cm		8-B10 60max
	35.5 in / 90 cm		-
	-		-
	40 in / 102 cm		-
	150 in / 381 cm	AVL	110V















Chandelier		1303	
	(H)		(-40)
	12 lbs / 5.4 kg		-
	24in / 61cm		6-B10 60max
	28in / 71cm		-
	-		-
	40in/120cm		-
	120in / 305cm	AVL	110V



Chandelier		1302	
	(H)		(-40)
	9 lbs / 4.1 kg		-
	20.5 in / 52 cm		5-B10 60max
	24 in / 61 cm		-
	-		-
	40 in / 102 cm		-
	122 in / 310 cm	AVL	110V



Wall Sconce		1301	
 (H)	 (-40)		
 5 lbs / 2.3 kg	 -		

	14.5 in / 37 cm		2-B10 60max
	16 in / 41 cm		-
	6 in / 15 cm		-
	-		-
	-	AVL	110V

Bagatelle

A dainty, playful musical composition; an ephemeral love affair. We offer a new interpretation of a classic lantern, a fanciful dance of crystal rosettes and drops around a sculptural crystal basket. Place it as a centerpiece in any room for a striking effect.

Canopy Options



110V



110V

*For 220V canopy information:
please contact customer service

Crystal Options



Heritage Crystal
(H)



Spectra Crystal
(A)



Crystals from Swarovski
(S)

Finish Options



Heirloom Gold
(-22)



Etruscan Gold
(-23)



French Gold
(-26)



Polished Silver
(-40)



Antique Silver
(-48)



Heirloom Bronze
(-76)















Aurelia
(-211)







Chandelier		1260	
 (A)	 (-76)		
 29 lbs / 13.1 kg	 -		

	35 in / 89 cm		10-B10 60max
	24.5 in / 62 cm		3-G12 40max, incl.
	-		10-B35 40max
	40 in / 102 cm		3-T26 25max, incl.
	128 in / 325 cm	AVL	110V, 220V



Chandelier		1248	
◊ (H)	○ (-22)		
⊙ 23 lbs / 10.4 kg	☀ -		
↔ 26.5 in / 67 cm	💡 ₁₁₀ 8-B10 60max		
↑↓ 29 in / 74 cm	💡 ₁₁₀ 3-G12 40max		
↘ -	💡 ₂₂₀ 8-B35 40max		
↓ 40 in / 102 cm	💡 ₂₂₀ 3-T26 25max		
🌀 120 in / 305 cm	AVL 110V, 220V, CCC		



Chandelier		1246	
◊ (H)	○ (-76)		
⊙ 13 lbs / 5.9 kg	☀ -		
↔ 21 in / 53 cm	💡 ₁₁₀ 6-B10 60max		
↑↓ 22.5 in / 57 cm	💡 ₁₁₀ 1-G161/2 60max		
↘ -	💡 ₂₂₀ 6-B35 40max		
↓ 40 in / 102 cm	💡 ₂₂₀ 1-T26 25max		
🌀 124 in / 315 cm	AVL 110V, 220V, CCC		



Chandelier		1238	
◊ (H)	○ (-48)		
⊙ 23 lbs / 10.4 kg	☀ -		
↔ 26.5 in / 67 cm	💡 ₁₁₀ 8-B10 60max		
↑↓ 24.5 in / 62 cm	💡 ₁₁₀ 3-G12 40max		
↘ -	💡 ₂₂₀ 8-B35 40max		
↓ 40 in / 102 cm	💡 ₂₂₀ 3-T26 25max		
🌀 124 in / 315 cm	AVL 110V, 220V		















Pendant		1243	
	(H)		(-48)
	8 lbs / 3.6 kg		-
	10.5 in / 27 cm		3-B10 60max
	12.5 in / 32 cm		-
	-		3-B35 40max
	40 in / 102 cm		-
	130 in / 330 cm	AVL	110V, 220V, CCC







Pendant		1241	
	(H)		(-23)
	5 lbs / 2.3 kg		-
	8 in / 20 cm		1-A19 100max
	9.5 in / 24 cm		-
	-		1-A55 40max
	40 in / 102 cm		-
	142 in / 361 cm	AVL	110V, 220V











Close to Ceiling		1242	
	(H)		(-76)
	8 lbs / 3.6 kg		-





	10.5 in / 27 cm		3-B10 40max
	12 in / 30 cm		-
	-		3-B35 25max
	-		-
	-	AVL	110V, 220V











Close to Ceiling		1239	
	(H)		(-22)
	3.5 lbs / 1.6 kg		-

	8 in / 20 cm		1-A19 100max
	9.5 in / 24 cm		-
	-		1-A55 40max
	-		-
	-	AVL	110V, 220V



Wall Sconce		1240	
 (H)	 (-22)		
 5 lbs / 2.3 kg	 -		

 8 in / 20 cm	 110	1-A19 100max
 13 in / 33 cm	 110	-
 10.5 in / 27 cm	 220	1-A55 40max
 -	 220	-
 -	AVL	110V, 220V

Bordeaux

Louis XIV, the 'Roi Soleil,' transformed his father's hunting pavilion in Versailles into a breathtaking château flaunting the finest artworks and ornaments. The opulent Hall of Mirrors, where 43 luxurious chandeliers held over 1000 candles, is the inspiration for our Bordeaux design, which celebrates the majestic castle.

* Product only available in 110V

Crystal Options



Legacy Crystal (L)

Finish Options



Heirloom Gold (-22)



Etruscan Gold (-23)



French Gold (-26)



Heirloom Bronze (-76)



Antique Silver (-48)















Textured Bronze (-73)







Chandelier		5782	
 (L)	 (-22)		
		56 lbs / 25.2 kg	-

	40 in / 102 cm		25-B10 60max
	64.5 in / 164 cm		-
	-		-
	126 in / 320 cm		-
	203 in / 516 cm	AVL	110V



Chandelier		5775	
	(L)		(-48)
	52 lbs / 23.4 kg		-

	40 in / 102 cm		25-B10 60max
	48 in / 122 cm		-
	-		-
	84 in / 213 cm		-
	211 in / 536 cm	AVL	110V



Chandelier		5771	
	(L)		(-48)
	22 lbs / 9.9 kg		-





	28 in / 71 cm		8-B10 60max
	32 in / 81 cm		-
	-		-
	40 in / 102 cm		-
	150 in / 381 cm	AVL	110V











Chandelier		5770	
	(L)		(-23)
	16 lbs / 7.2 kg		-

	22 in / 56 cm		6-B10 60max
	29 in / 74 cm		-
	-		-
	40 in / 102 cm		-
	153 in / 389 cm	AVL	110V



Wall Sconce		5766	
 (L)	 (-76)		
 6 lbs / 2.7 kg	 -		

	11.5 in / 29 cm		2-B10 60max
	21.5 in / 55 cm		-
	9 in / 23 cm		-
	-		-
	-	AVL	110V

Camelot

As Napoleon embarked on a journey for regional domination, he looked back at the glorious days of the Greek and Roman empires, celebrating the virtues of Antiquity's military and cultural powers. Corinthian richness and splendor filled castles and private homes, combining the geometry of classicism with lavish stones and metals. Camelot is a dense plethora of crystals reminiscent of eras of true imperial splendor.

* Product only available in 110V

Crystal Options



Gemcut Crystal
(M)

Finish Options



Polished Silver
(-40)







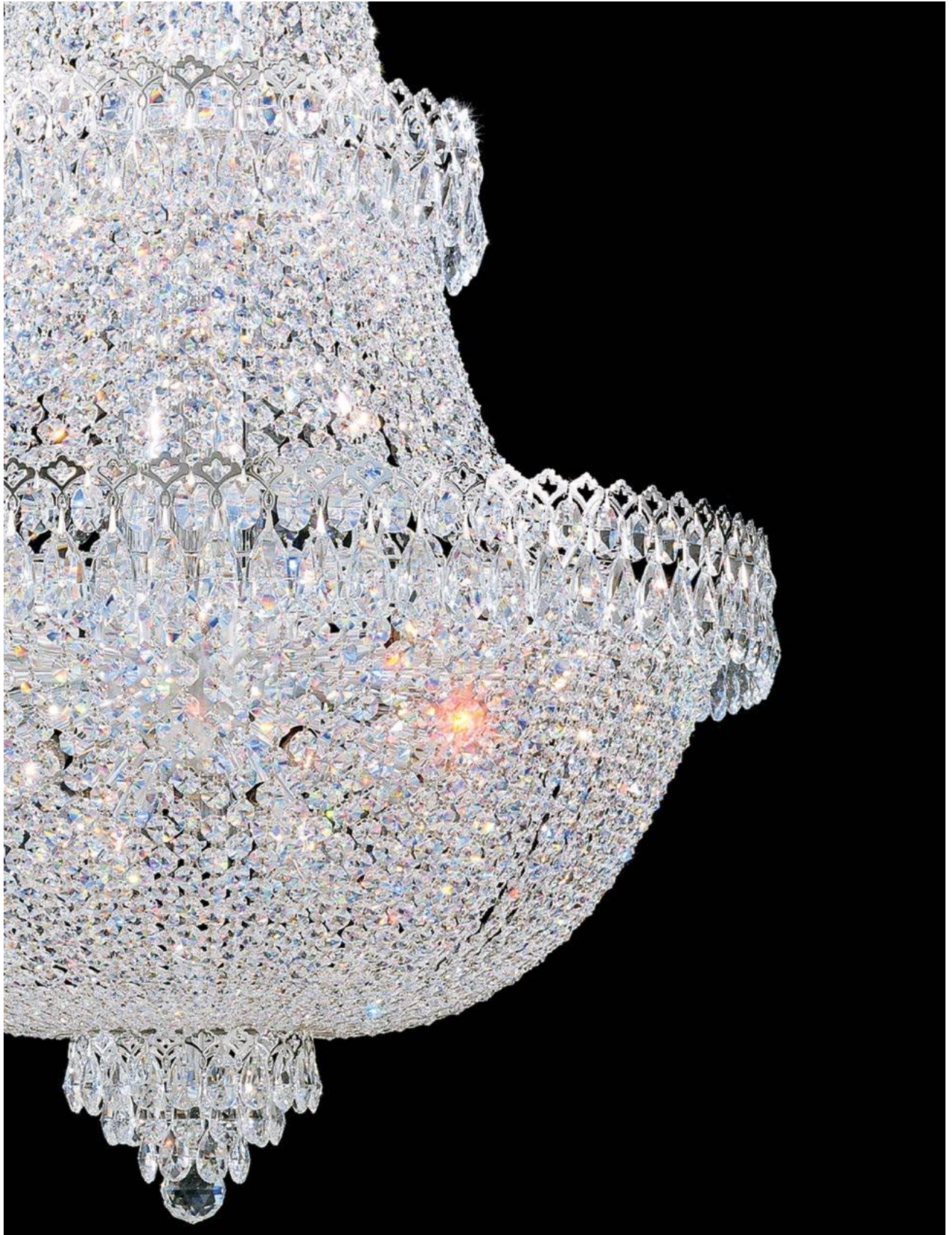







Aurelia
(-211)







Chandelier		2642	
 (M)	 (-211)		
 66 lbs / 29.7 kg	 -		

 34 in / 86 cm	 57-B10 60max
 60 in / 152 cm	 -
 -	 -
 126 in / 320 cm	 -
 194 in / 493 cm	AVL 110V



Chandelier		2638	
(M)	(-40)		
50 lbs / 22.5 kg	-		
28 in / 71 cm	110	41-B10 60max	
49.5 in / 126 cm	110		
-	220		
120 in / 305 cm	220		
201 in / 511 cm	AVL	110V	



Chandelier		2628	
(M)	(-211)		
36 lbs / 16.2 kg	-		
28 in / 71 cm	110	31-B10 60max	
40 in / 102 cm	110		
-	220		
80 in / 203 cm	220		
151 in / 384 cm	AVL	110V	



Chandelier		2626	
(M)	(-40)		
28 lbs / 12.6 kg	-		
24 in / 61 cm	110	22-B10 60max	
36 in / 91 cm	110		
-	220		
40 in / 102 cm	220		
154 in / 391 cm	AVL	110V	



Chandelier		2622	
(M)	(-211)		
16 lbs / 7.2 kg	-		
19.5 in / 50 cm	110	12-B10 60max	
28 in / 71 cm	110		
-	220		
40 in / 102 cm	220		
122 in / 310 cm	AVL	110V	



Close to Ceiling		2618	
	(M)		(-211)
	11 lbs / 5.0 kg		-
	19.5 in / 50 cm		6-B10 40max
	11 in / 28 cm		-
	-		-
	-		-
	-	AVL	110V



Close to Ceiling		2616	
	(M)		(-211)
	4 lbs / 1.8 kg		-
	11 in / 28 cm		3-G161/2 40max
	7 in / 18 cm		-
	-		-
	-		-
	-	AVL	110V

Century

The ultimate heirloom chandelier, regal and refined, timeless and classic. A masterpiece of cascading crystals with an intricately cut crystal column, Century is fit for a ballroom, a stately dining room or a grand residence.

Canopy Options



110V*

*For 220V canopy information:
please contact customer service

Crystal Options



Heritage Crystal
(H)

Finish Options



Heirloom Gold
(-22)



Etruscan Gold
(-23)



French Gold
(-26)



Polished Silver
(-40)



Aurelia
(-211)



Antique Silver
(-48)















Black Pearl
(-49)



















Chandelier		1718	
 (H)	 (-49)		60 lbs / 27.0 kg





	42.5 in / 108 cm		28-B10 60max
	41 in / 104 cm		-
	-		28-B35 40max
	84 in / 213 cm		-
	208 in / 528 cm	AVL	110V, 220V, CCC











Chandelier		1829	
 (H)	 (-211)		
 4 lbs / 1.8 kg	 -		

 12.5 in / 32 cm	 110	1-A19 100max	
 14 in / 36 cm	 110 ^{max}	-	
 -	 220	1-B35 40max	
 40 in / 102 cm	 220 ^{max}	-	
 140 in / 356 cm	AVL	110V, 220V, CCC	



Chandelier		1716	
 (H)	 (-40)		
 48 lbs / 21.6 kg	 -		

 37 in / 94 cm	 110	20-B10 60max	
 54.5 in / 138 cm	 110 ^{max}	-	
 -	 220	20-B35 40max	
 120 in / 305 cm	 220 ^{max}	-	
 197 in / 500 cm	AVL	110V, 220V, CCC	















Chandelier		1712	
	(H)		(-211)
	26 lbs / 11.7 kg		-
	30 in / 76 cm		12-B10 60max
	29.5 in / 75 cm		-
	-		12-B35 40max
	40 in / 102 cm		-
	153 in / 389 cm	AVL	110V, 220V, CCC















Chandelier		1709	
	(H)		(-211)
	18 lbs / 8.1 kg		-
	26 in / 66 cm		9-B10 60max
	22 in / 56 cm		-
	-		9-B35 40max
	40 in / 102 cm		-
	124 in / 315 cm	AVL	110V, 220V, CCC















Chandelier		1707	
	(H)		(-49)
	17 lbs / 7.7 kg		-
	24 in / 61 cm		8-B10 60max
	21.5 in / 55 cm		-
	-		8-B35 40max
	40 in / 102 cm		-
	125 in / 318 cm	AVL	110V, 220V, CCC















Chandelier		1705	
	(H)		(-40)
	14 lbs / 6.3 kg		-
	21 in / 53 cm		6-B10 60max
	20 in / 51 cm		-
	-		6-B35 40max
	40 in / 102 cm		-
	127 in / 323 cm	AVL	110V, 220V, CCC







Chandelier		1704	
	(H)		(-211)
	9 lbs / 4.1 kg		-
	17 in / 43 cm		5-B10 60max
	17 in / 43 cm		-
	-		5-B35 40max
	40 in / 102 cm		-
	129 in / 328 cm	AVL	110V, 220V, CCC











Wall Sconce		1703	
 (H)	 (-211)		
 4 lbs / 1.8 kg		-	





 13 in / 33 cm	 110	3-B10 60max	
 17.5 in / 44 cm	 110 nd	-	
 6 in / 15 cm	 220	3-B35 40max	
 -	 220 nd	-	
 -	AVL	110V, 220V	



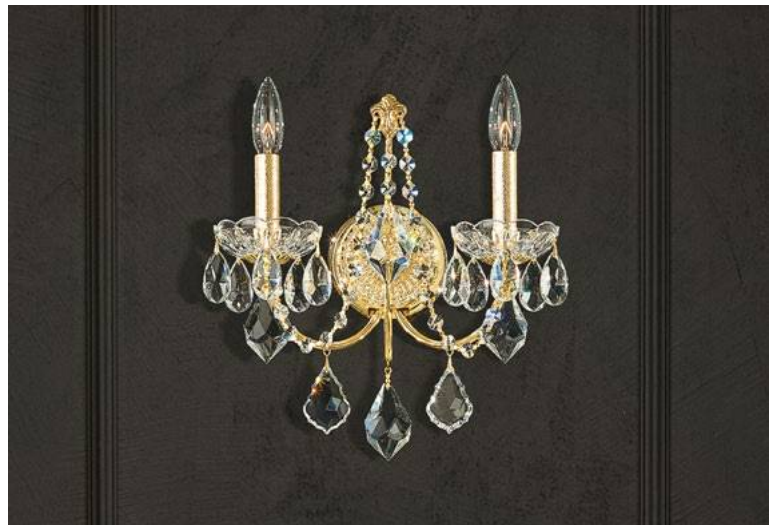







Wall Sconce		1702	
 (H)	 (-211)		
 4 lbs / 1.8 kg		-	

 12 in / 30 cm	 110	2-B10 60max	
 14 in / 36 cm	 110 nd	-	
 5.5 in / 14 cm	 220	2-B35 40max	
 -	 220 nd	-	
 -	AVL	110V, 220V	



Wall Sconce		1701	
 (H)	 (-40)		
 2 lbs / 0.9 kg		-	

 4.5 in / 11 cm	 110	1-B10 60max	
 13 in / 33 cm	 110 nd	-	
 6 in / 15 cm	 220	1-B35 40max	
 -	 220 nd	-	
 -	AVL	110V, 220V	



Chrysalita

Like an heirloom cascade of diamonds, Chrysalita's ethereal crystal basket is enhanced with fine strands of crystal-embellished chains. This delicately beautiful piece culminates in a faceted finial drop cut exclusively for Schonbek. While Chrysalita's large chandeliers will delight in grand ballrooms, the smaller designs are ideal for your elegant home.

Canopy Options



110V



220V

Crystal Options



Spectra Crystal
(A)

Finish Options



Polished
Stainless Steel
(-401)





Chandelier		CM8334		↔	33.5 in / 85 cm	💡 110	8-G9 40max
				↑	41 in / 104 cm	💡 110	-
				↘	-	💡 220	8-G9 40max
				↓	40 in / 102 cm	💡 220	-
				100	114 in / 290 cm	AVL	110V, 220V
🔹	(A)	○	(-401)	⊙	33 lbs / 14.9 kg	☀️	-















Chandelier		CM8326	
	(A)		(-401)
	21 lbs / 9.5 kg		-
	25 in / 64 cm		6-G9 40max
	33 in / 84 cm		-
	-		6-G9 40max
	40 in / 102 cm		-
	118 in / 300 cm	AVL	110V, 220V







Chandelier		CM8319	
	(A)		(-401)
	10 lbs / 4.5 kg		-
	18.5 in / 47 cm		6-G9 40max
	25.5 in / 65 cm		-
	-		6-G9 40max
	40 in / 102 cm		-
	124 in / 315 cm	AVL	110V, 220V











Close to Ceiling		CM8426	
	(A)		(-401)
	17 lbs / 7.7 kg		-





	25.5 in / 65 cm		5-G9 40max
	13.5 in / 34 cm		-
	-		5-G9 40max
	-		-
	-	AVL	110V, 220V











Close to Ceiling		CM8419	
	(A)		(-401)
	9 lbs / 4.1 kg		-

	18.5 in / 47 cm		4-G9 40max
	11.5 in / 29 cm		-
	-		4-G9 40max
	-		-
	-	AVL	110V, 220V



Wall Sconce		CM8519	
 (A)	 (-401)		
 5 lbs / 2.3 kg	 -		

	17 in / 43 cm		2-G9 40max
	9,5 in / 24 cm		-
	7 in / 18 cm		2-G9 40max
	-		-
	-	AVL	110V, 220V

Da Vinci

The great Renaissance man Leonardo da Vinci was known for his scientific and artistic inventions. Our homage to the genius, Da Vinci is a magnificent sphere of light composed of hundreds of crystal octagons. Streamlined and dense with a thousand facets of cut glass, this shimmering globe comes in a suspension form.

* Product only available in 110V

Crystal Options

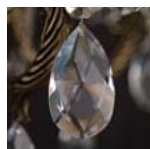

Spectra Crystal
(A)

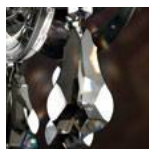

Crystals from Swarovski
(S)

Finish Options







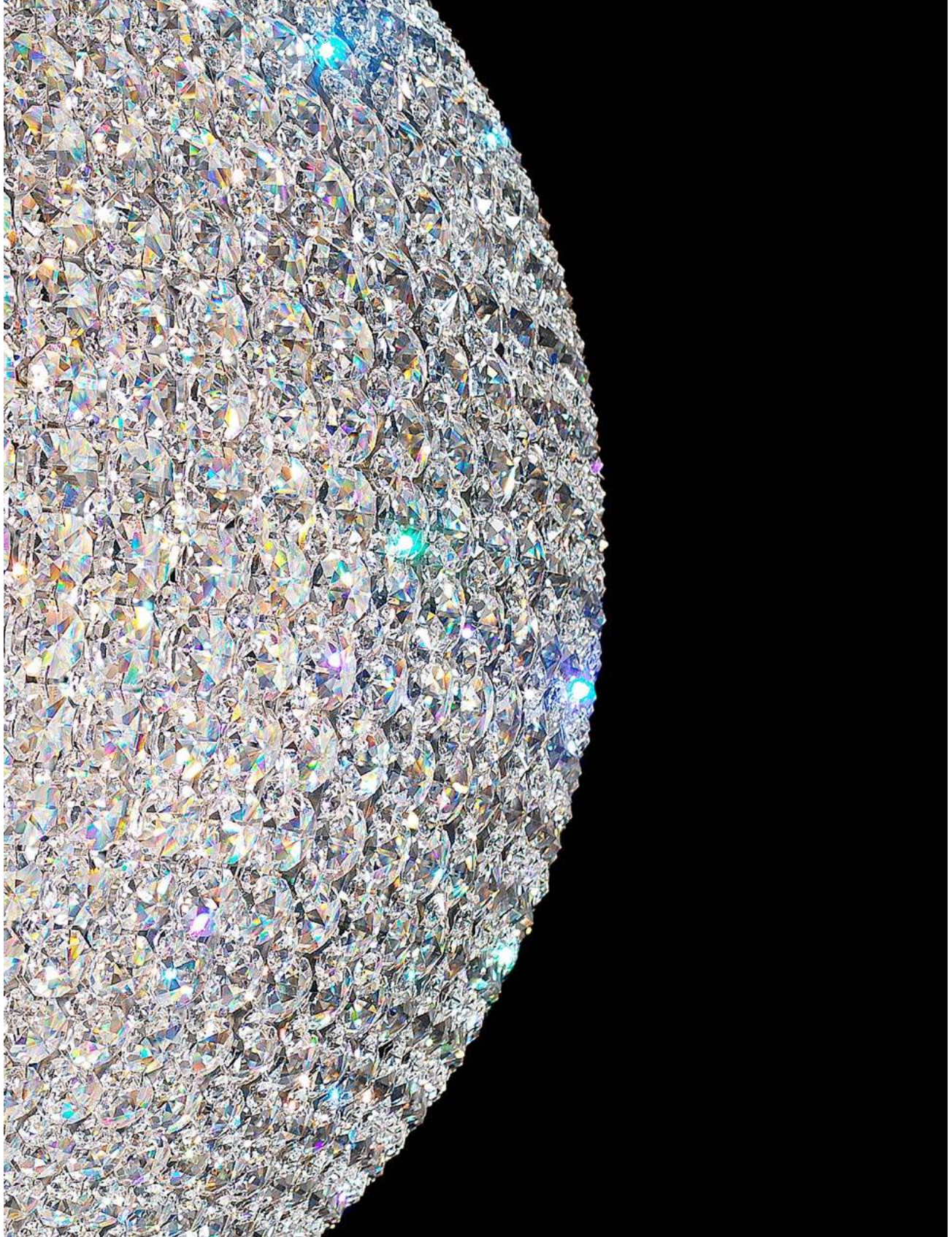







Polished
Stainless Steel
(-401)























Pendant		DV1818	
	(A)		(-401)
	33 lbs / 14.9 kg		-









	18 in / 46 cm		18-G9 40max
	18 in / 46 cm		-
	-		-
	144 in / 366 cm		-
	131 in / 333 cm	AVL	110V



Pendant		DV1515			15 in / 38 cm		16-G9 40max
					15 in / 38 cm		-
	(A)		(-401)		-		-
	31 lbs / 14.0 kg		-		144 in / 366 cm		-
					131 in / 333 cm	AVL	110V



Pendant		DV1212	
	(A)		(-401)
	17 lbs / 7.7 kg		-

	12 in / 30 cm		12-G9 40max
	12 in / 30 cm		-
	-		-
	144 in / 366 cm		-
	134 in / 340 cm	AVL	110V



Equinoxe

When the earth's center passes through the sun, the northern and southern hemispheres are equally illuminated. A massive explosion of crystal and light, Equinoxe is composed of a matrix of eight-point star shapes inspired by ancient mosaics, showcasing the grandeur and craft of nineteenth-century Bohemian traditions.

* Product only available in 110V

Crystal Options



Gemcut Crystal
(M)

Finish Options



Polished Silver
(-40)















Aurelia
(-211)

































Chandelier		2727	
 (M)	 (-40)		
 100 lbs / 45.0 kg	 -		

 29.5 in / 75 cm	 63-B10 60max
 58 in / 147 cm	 -
 -	 -
 84 in / 213 cm	 -
 198 in / 503 cm	AVL 110V















Chandelier		2726	
 (M)	 (-211)		
 66 lbs / 29.7 kg	 -		
 29.5 in / 75 cm	 45-B10 60max		
 36 in / 91 cm	 110 -		
 -	 220 -		
 84 in / 213 cm	 220 -		
 152 in / 386 cm	AVL 110V		



Chandelier		2725	
 (M)	 (-211)		
 56 lbs / 25.2 kg	 -		
 22.5 in / 57 cm	 35-B10 60max		
 41.5 in / 105 cm	 110 -		
 -	 220 -		
 84 in / 213 cm	 220 -		
 153 in / 389 cm	AVL 110V		



Chandelier		2716	
 (M)	 (-211)		
 50 lbs / 22.5 kg	 -		

 29.5 in / 75 cm	 31-B10 60max
 23 in / 58 cm	 -
 -	 -
 42 in / 107 cm	 -
 165 in / 419 cm	AVL 110V

Filigrae

The masquerades of the Renaissance, in Florence, Venice or Paris, were remarkable in their lavishness and inventiveness. Filigrae, a chef d'oeuvre of ornate precious branches and heavy crystals, celebrates the festive spirit of the sixteenth century's masked balls.

Canopy Options



110V

* Product only available in 110V

Crystal Options



Heritage Crystal
(H)



Spectra Crystal
(A)

Finish Options



Etruscan Gold
(-23)



French Gold
(-26)



Antique Silver
(-48)



Heirloom Bronze
(-76)





Chandelier		FE7018		↔	39 in / 99 cm	⚡ 110	18-B10 60max
				↑	38 in / 97 cm	⚡ 110	-
				↘	-	⚡ 220	-
				↓	40 in / 102 cm	⚡ 220	-
				∞	143 in / 363 cm	AVL	110V
⚡	(A)	○	(-26)				
⚡	42 lbs / 18.9 kg	⚡	-				















Chandelier		FE7066	
	(H)		(-23)
	18 lbs / 8.1 kg		-
	24 in / 61 cm		6-B10 60max
	22 in / 56 cm		-
	-		-
	40 in / 102 cm		-
	123 in / 312 cm	AVL	110V







Chandelier		FE7006	
	(A)		(-76)
	16 lbs / 7.2 kg		-
	22.5 in / 57 cm		6-B10 60max
	26 in / 66 cm		-
	-		-
	40 in / 102 cm		-
	154 in / 391 cm	AVL	110V











Close to Ceiling		FE7206		 23 in / 58 cm	 110	6-B10 40max
				 18.5 in / 47 cm	 110	-
 (A)	 (-48)			 -	 220	-
 18 lbs / 8.1 kg	 -			 -	 220	-
				 -	AVL	110V





Wall Sconce		FE7002	
 (A)	 (-48)		
 4 lbs / 1.8 kg	 -		

	14 in / 36 cm		2-B10 60max
	16 in / 41 cm		-
	9.5 in / 24 cm		-
	-		-
	-	AVL	110V

Hamilton

A multilayered chandelier with hand-formed crystal arms and hand-cut crystals, Hamilton is a true heirloom piece of palatial grandeur. A distinguished silhouette is elongated with scale in mind for a bold yet classic addition to any lobby or restaurant space.

Crystal Options



Heritage Crystal
(H)



Heritage Jet Black (BK)
Must Be With (-55)

Finish Options



Polished Silver
(-40)















Jet Black
(-55)



















Chandelier		5708	
 (CL)	 (-40)		
 48 lbs / 21.6 kg	 -		





	30 in / 76 cm		12-B10 60max
	44 in / 112 cm		-
	-		12-B35 40max
	40 in / 102 cm		-
	144 in / 366 cm	AVL	110V, 220V, CCC











Chandelier		5737	
	(CL)		(-55)
	33 lbs / 14.9 kg		-

	28 in / 71 cm		8-B10 60max
	35 in / 89 cm		-
	-		8-B35 40max
	40 in / 102 cm		-
	152 in / 386 cm	AVL	110V, 220V, CCC



Wall Sconce		5701	
	(CL)		(-40)
	3 lbs / 1.4 kg		-

	5 in / 13 cm		1-B10 60max
	17 in / 43 cm		-
	7.5 in / 19 cm		1-B35 40max
	-		-
	-	AVL	110V, 220V



Hamilton Rock Crystal

The decadently playful medley of Hamilton Rock Crystal's rare colored rock crystal drops, heavy pendants, garlands and icicles creates a fantasy of texture and light.

Crystal Options



Rock Crystal: Heritage
Crystal Clear Amethyst (AM)



Rock Crystal: Heritage
Crystal Clear (CL)



Rock Crystal: Heritage
Crystal Clear Jet (BK)

Finish Options







Polished Silver
(-40)











Jet Black
(-55)





Chandelier		5536	
	(AM)		(-40)
	27 lbs / 12.2 kg		-

	24 in / 61 cm		7-B10 60max
	31 in / 79 cm		-
	-		7-B35 40max
	40 in / 102 cm		-
	155 in / 394 cm	AVL	110V, 220V



Chandelier		5535		↔	22 in / 56 cm	💡 110	6-B10 60max
				↕	29.5 in / 75 cm	💡 110	-
	(AM)	○	(-40)	↗	-	💡 220	6-B35 40max
	22 lbs / 9.9 kg		-	↓	40 in / 102 cm	💡 220	-
				∞	157 in / 399 cm	AVL	110V, 220V



La Scala

The soft curves, leaf-like motifs, rich crystal garlands and flower-shaped cups of La Scala evoke the sixteenth-century chandeliers of the Rococo. Its ornate arms and scrolls are cast by hand from Schonbek family molds.

* Product only available in 110V

Crystal Options



Heritage Crystal
(H)



Spectra Crystal
(A)



Crystals from Swarovski
(S)

Finish Options



Heirloom Gold
(-22)



Etruscan Gold
(-23)



French Gold
(-26)



Parchment Gold
(-27)



Antique Silver
(-48)



Parchment
Bronze
(-74)



Heirloom Bronze
(-76)



Roman Silver
(-80)



Florentine Bronze
(-83)















Midnight Gild
(-86)







Chandelier		5013	
 (H)	 (-27)		
		102 lbs / 45.9 kg	-

	46 in / 117 cm		24-B10 60max
	48 in / 122 cm		-
	-		-
	126 in / 320 cm		-
	142 in / 361 cm	AVL	110V



Chandelier		5075	
	(H)		(-48)
	44 lbs / 20.0 kg		-
	28 in / 71 cm		15-B10 60max
	32 in / 81 cm		-
	-		-
	120 in / 305 cm		-
	161 in / 409 cm	AVL	110V



Chandelier		5074	
	(H)		(-74)
	35 lbs / 15.8 kg		-
	28 in / 71 cm		10-B10 60max
	29.5 in / 75 cm		-
	-		-
	120 in / 305 cm		-
	156 in / 396 cm	AVL	110V



Chandelier		5073	
	(H)		(-22)
	27 lbs / 12.2 kg		-
	25 in / 64 cm		8-B10 60max
	28.5 in / 72 cm		-
	-		-
	80 in / 203 cm		-
	157 in / 399 cm	AVL	110V



Chandelier		5072	
	(H)		(-74)
	20 lbs / 9.0 kg		-
	23 in / 58 cm		6-B10 60max
	25 in / 64 cm		-
	-		-
	80 in / 203 cm		-
	123 in / 312 cm	AVL	110V



Chandelier		5011	
	(H)		(-22)
	80 lbs / 36.0 kg		-

	33 in / 84 cm		12-B10 60max
	41 in / 104 cm		-
	-		-
	84 in / 213 cm		-
	148 in / 376 cm	AVL	110V



Chandelier		5008	
	(H)		(-74)
	50 lbs / 22.5 kg		-

	28 in / 71 cm		10-B10 60max
	38 in / 97 cm		-
	-		-
	126 in / 320 cm		-
	150 in / 381 cm	AVL	110V



Chandelier		5007	
	(S)		(-83)
	36 lbs / 16.2 kg		-

	25 in / 64 cm		8-B10 60max
	34 in / 86 cm		-
	-		-
	80 in / 203 cm		-
	154 in / 391 cm	AVL	110V





Close to Ceiling		5345	
	(H)		(-48)
	11 lbs / 5.0 kg		-

	18 in / 46 cm		5-B10 40max
	20.5 in / 52 cm		-
	-		-
	40 in / 102 cm		-
	126 in / 320 cm	AVL	110V



Wall Sconce		5071	
	(H)		(-22)
	5 lbs / 2.3 kg		-
	11.5 in / 29 cm		3-B10 60max
	17 in / 43 cm		-
	7.5 in / 19 cm		-
	-		-
	-	AVL	110V



Wall Sconce		5070	
	(H)		(-48)
	5 lbs / 2.3 kg		-
	11.5 in / 29 cm		2-B10 60max
	16.5 in / 42 cm		-
	6.5 in / 17 cm		-
	-		-
	-	AVL	110V



Wall Sconce		5069	
	(H)		(-74)
	3 lbs / 1.4 kg		-
	5 in / 13 cm		1-B10 60max
	16 in / 41 cm		-
	8 in / 20 cm		-
	-		-
	-	AVL	110V



Wall Sconce		5001	
	(A)		(-76)
	6 lbs / 2.7 kg		-
	15 in / 38 cm		2-B10 60max
	17 in / 43 cm		-
	6 in / 15 cm		-
	-		-
	-	AVL	110V



Milano

The baroque castings of Milano, made in Italy, feature delicate ornamentations that celebrate the heritage of the great Italian chandeliers of the seventeenth Century. Heavy crystals enhance the lace-like precious metal body.

Canopy Options



110V*

*For 220V canopy information: please contact customer service

Crystal Options



Crystals from Swarovski Golden Shadow (GS)



Crystals from Swarovski (S)



Spectra Crystal (A)



Crystals from Swarovski Silver Shade (SH)



Optic Crystal (O)



Crystals from Swarovski Golden Teak (TK)

Finish Options



Heirloom Gold (-22)



Etruscan Gold (-23)



French Gold (-26)



Parchment Gold (-27)



Antique Silver (-48)



Parchment Bronze (-74)



Heirloom Bronze (-76)



Roman Silver (-80)



Floretine Bronze (-83)















Midnight Gild (-86)







Chandelier		5688	
 (SH)	 (-86)		
 133 lbs / 59.9 kg	 -		

	50 in / 127 cm		28-B10 60max
	68 in / 173 cm		-
	-		28-B35 40max
	126 in / 320 cm		-
	141 in / 358 cm	AVL	110V, 220V, CCC



Chandelier		5686	
	(S)		(-83)
	70 lbs / 31.5 kg		-





	39 in / 99 cm		15-B10 60max
	48.5 in / 123 cm		-
	-		15-B35 40max
	84 in / 213 cm		-
	145 in / 368 cm	AVL	110V, 220V, CCC











Chandelier		5685	
	(O)		(-23)
	52 lbs / 23.4 kg		-

	38.5 in / 98 cm		15-B10 60max
	38 in / 97 cm		-
	-		15-B35 40max
	42 in / 107 cm		-
	159 in / 404 cm	AVL	110V, 220V, CCC



Chandelier		5683	
	(SH)		(-80)
	32 lbs / 14.4 kg		-

	31 in / 79 cm		12-B10 60max
	40 in / 102 cm		-
	-		12-B35 40max
	40 in / 102 cm		-
	146 in / 371 cm	AVL	110V, 220V, CCC



Chandelier		5682	
	(O)		(-22)
	31 lbs / 14.0 kg		-

	32.5 in / 83 cm		12-B10 60max
	33.5 in / 85 cm		-
	-		12-B35 40max
	40 in / 102 cm		-
	121 in / 307 cm	AVL	110V, 220V, CCC



Chandelier		5679	
	(A)		(-27)
	30 lbs / 13.5 kg		-

	30 in / 76 cm		9-B10 60max
	31 in / 79 cm		-
	-		9-B35 40max
	40 in / 102 cm		-
	153 in / 389 cm	AVL	110V, 220V















Chandelier		5677	
	(O)		(-26)
	19.5 lbs / 8.8 kg		-
	27 in / 69 cm		7-B10 60max
	28.5 in / 72 cm		-
	-		7-B35 40max
	40 in / 102 cm		-
	120 in / 305 cm	AVL	110V, 220V, CCC







Chandelier		5676	
	(A)		(-83)
	15 lbs / 6.8 kg		-
	24 in / 61 cm		6-B10 60max
	26.5 in / 67 cm		-
	-		6-B35 40max
	40 in / 102 cm		-
	120 in / 305 cm	AVL	110V, 220V, CCC











Close to Ceiling		5633	
	(A)		(-83)
	11 lbs / 5.0 kg		-





	16.5 in / 42 cm		2-B10 40max
	8 in / 20 cm		-
	-		2-B35 25max
	-		-
	-	AVL	110V, 220V











Wall Sconce		5643	
	(S)		(-27)
	3 lbs / 1.4 kg		-





	13 in / 33 cm		3-B10 60max
	15 in / 38 cm		-
	8.5 in / 22 cm		3-B35 40max
	-		-
	-	AVL	110V, 220V











Wall Sconce		5642	
	(GS)		(-83)
	3 lbs / 1.4 kg		-

	13.5 in / 34 cm		2-B10 60max
	15.5 in / 39 cm		-
	7.5 in / 19 cm		2-B35 40max
	-		-
	-	AVL	110V, 220V



Wall Sconce		5641	
	(SH)		(-80)
	2.5 lbs / 1.1 kg		-

	5 in / 13 cm		1-B10 60max
	13.5 in / 34 cm		-
	7 in / 18 cm		1-B35 40max
	-		-
	-	AVL	110V, 220V



New Orleans

Glowing with the joyous spirit of the epicurean southern hub, New Orleans features a French Baroque motif – a dance of twirling branches around a sculptural crystal column, decorated with a flight of garlands, cups and ornaments.

* Product only available in 110V

Crystal Options



Heritage Crystal (H)



Crystals from Swarovski (S)



Crystals from Swarovski Golden Teak (TK)

Finish Options



Heirloom Gold (-22)



Etruscan Gold (-23)



French Gold (-26)



Polished Silver (-40)



Antique Silver (-48)



Black Pearl (-49)



Heirloom Bronze (-76)







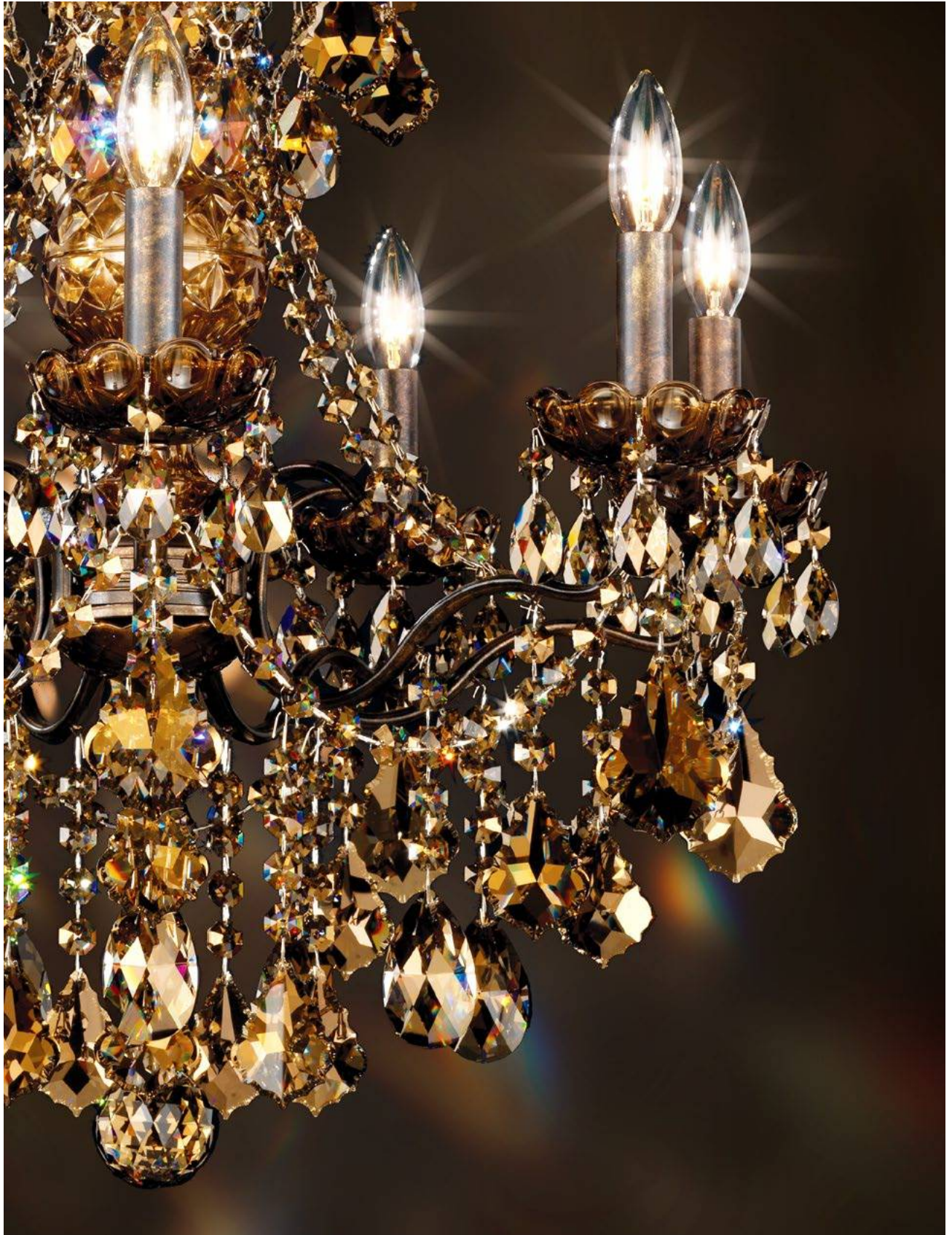







Aurelia (-211)







Chandelier		3660	
 (H)	 (-211)		
 54 lbs / 24.3 kg	 -		

 36 in / 91 cm	 110	18-B10 60max
 44 in / 112 cm	 110	-
 -	 220	-
 126 in / 320 cm	 220	-
 146 in / 371 cm	AVL	110V









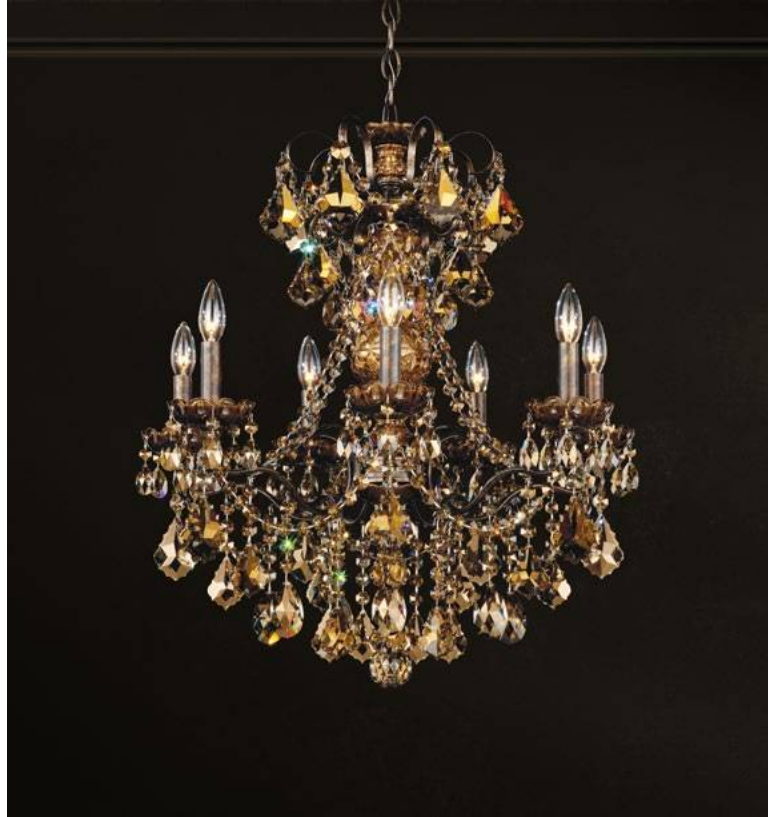





Chandelier		3658	
	(TK)		(-22)
	40 lbs / 18.0 kg		-
	32 in / 81 cm		14-B10 60max
	38.5 in / 98 cm		-
	-		-
	80 in / 203 cm		-
	149 in / 378 cm	AVL	110V















Chandelier		3657	
	(S)		(-26)
	24 lbs / 10.8 kg		-
	28 in / 71 cm		10-B10 60max
	31 in / 79 cm		-
	-		-
	40 in / 102 cm		-
	155 in / 394 cm	AVL	110V









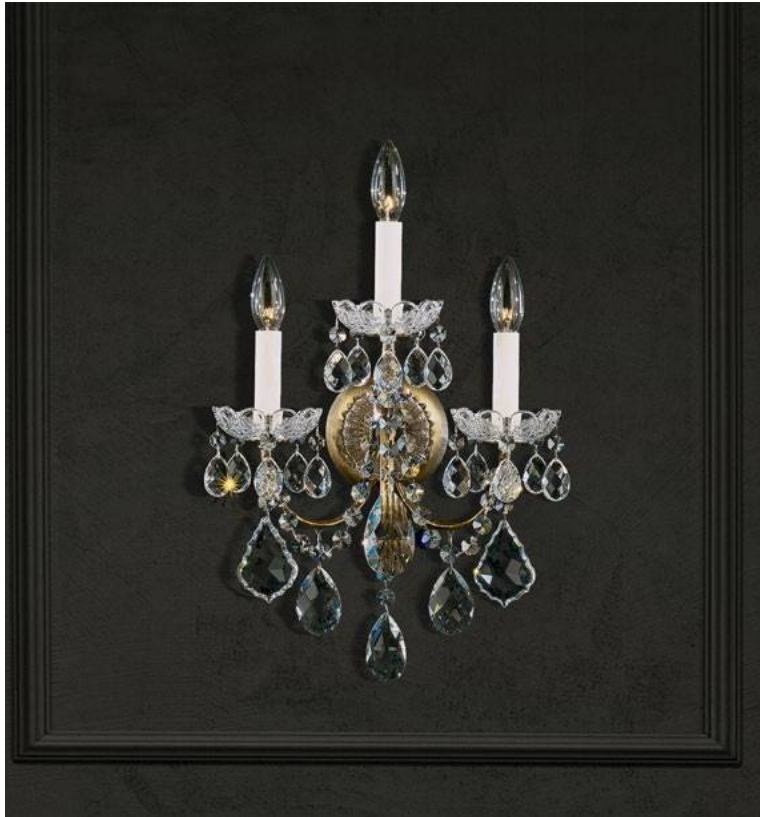





Chandelier		3656	
 (TK)	 (-76)		
 16 lbs / 7.2 kg	 -		
 24 in / 61 cm	 7-B10 60max		
 27 in / 69 cm	 -		
 -	 -		
 40 in / 102 cm	 -		
 122 in / 310 cm	AVL 110V		







Chandelier		3648	
 (TK)	 (-76)		
 4 lbs / 1.8 kg	 -		
 12 in / 30 cm	 4-B10 60max		
 16.5 in / 42 cm	 -		
 -	 -		
 40 in / 102 cm	 -		
 129 in / 328 cm	AVL 110V		



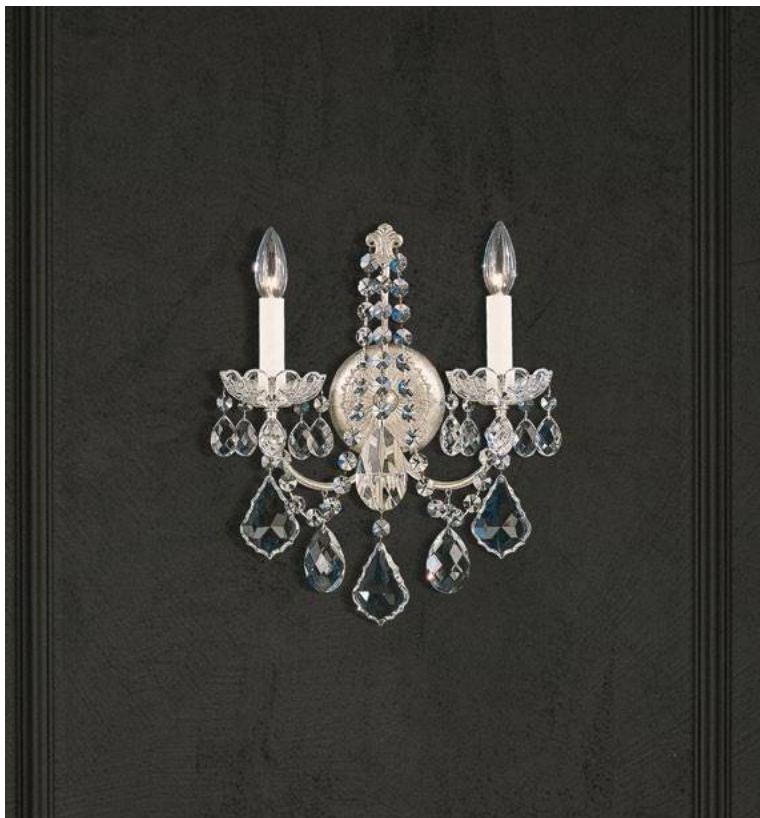







Wall Sconce		3652	
	(H)		(-23)
	4 lbs / 1.8 kg		-





	12 in / 30 cm		3-B10 60max
	18.5 in / 47 cm		-
	6 in / 15 cm		-
	-		-
	-	AVL	110V











Wall Sconce		3651	
	(H)		(-48)
	3 lbs / 1.4 kg		-

	12 in / 30 cm		2-B10 60max
	14.5 in / 37 cm		-
	5.5 in / 14 cm		-
	-		-
	-	AVL	110V



Wall Sconce		3650	
 (H)	 (-26)		
 2 lbs / 0.9 kg	 -		

 4.5 in / 11 cm	 110	1-B10 60max
 13 in / 33 cm	 110	-
 6 in / 15 cm	 220	-
 -	 220	-
 -	AVL	110V

Novielle

A re-interpretation of Adolf Schonbek's 1938 Morchenstern Collection, Novielle's hand-formed, twisted crystal arms and scrolls are accented by a new, hand-cut crystal column. Elegant trimmings adorn this true heritage design.

* Product only available in 110V

Crystal Options



Spectra Crystal
(A)



Crystals from Swarovski
(S)













Finish Options



Polished Silver
(-40)





Chandelier		NV3907			29 in / 74 cm		7-B10 60max
					35 in / 89 cm		-
	(S)		(-40)		-		-
	26 lbs / 11.7 kg		-		40 in / 102 cm		-
					154 in / 391 cm	AVL	110V



Chandelier		NV3905	
	(S)		(-40)
	15 lbs / 6.8 kg		-
	22 in / 56 cm		5-B10 60max
	27 in / 69 cm		-
	-		-
	40 in / 102 cm		-
	122 in / 310 cm	AVL	110V



Chandelier		NV3904	
	(A)		(-40)
	6 lbs / 2.7 kg		-
	14.5 in / 37 cm		4-B10 60max
	15.5 in / 39 cm		-
	-		-
	40 in / 102 cm		-
	130 in / 330 cm	AVL	110V

Olde World

Blossoming like a rare flower, with its graceful hand-formed crystal body and dense ornaments, Olde World is an homage to the legendary house of Schonbek, founded in Bohemia in 1870, and to the sumptuousness of nineteenth-century décors.

Crystal Options



Spectra Crystal
(A)



Crystals from Swarovski
(S)

Finish Options



Polished Silver
(-40)









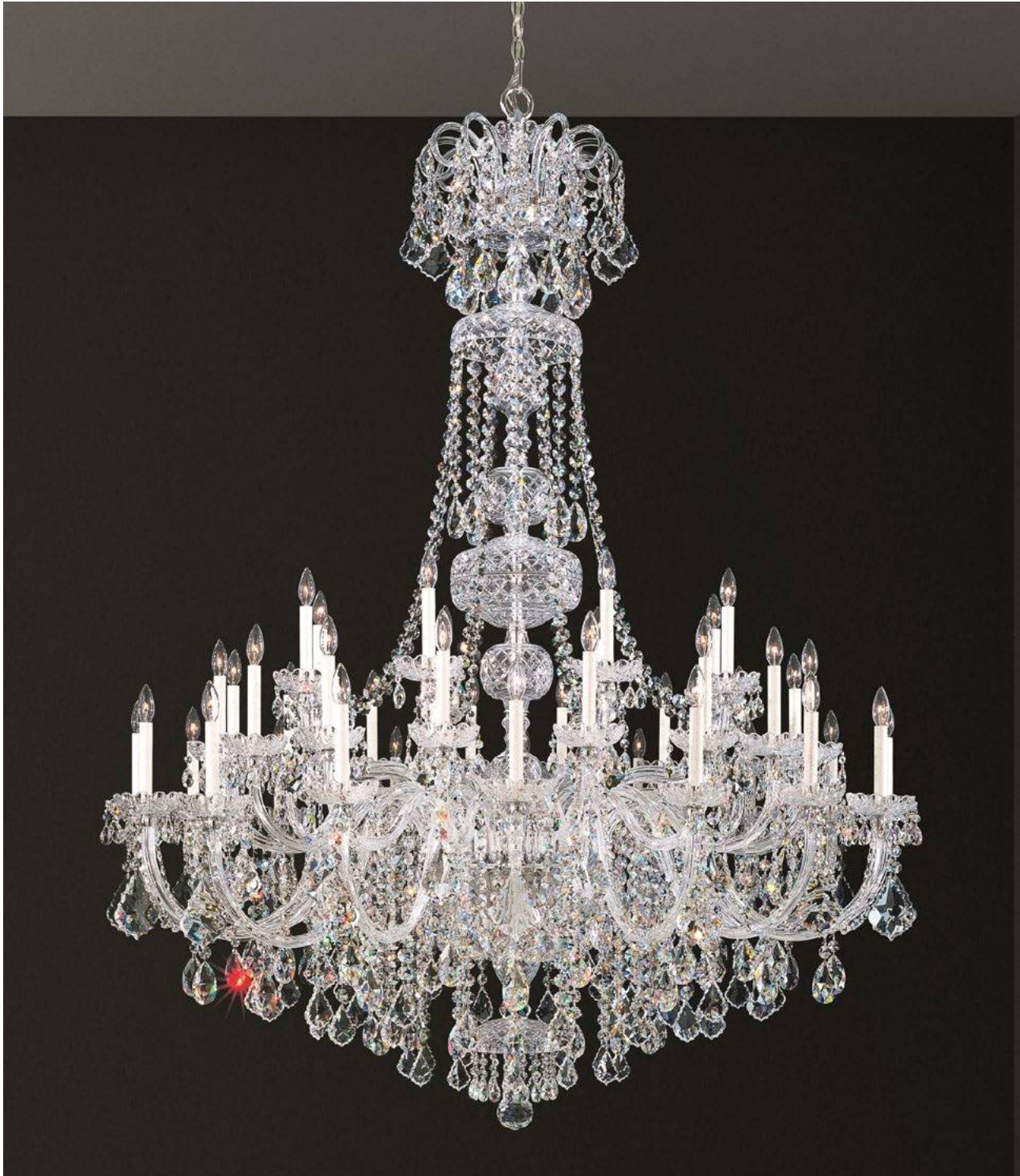







Aurelia
(-211)







Chandelier		6861	
 (S)	 (-40)		
	200 lbs / 90.0 kg		-

	60 in / 152 cm		5-B10 25max
	77 in / 196 cm		40-B10 60max
	-		3-B35 25max
	126 in / 320 cm		40-B35 40max
	181 in / 460 cm	AVL	110V, 220V, CCC



Chandelier		6860	
	(S)		(-40)
	62 lbs / 27.9 kg		-
	35.5 in / 90 cm		20-B10 60max
	46 in / 117 cm		5-C7 7.5max
	-		2-B35 25max
	126 in / 320 cm		20-B35 40max
	146 in / 371 cm	AVL	110V, 220V



Chandelier		6818	
	(S)		(-40)
	90 lbs / 40.5 kg		-
	36 in / 91 cm		18-B10 60max
	68 in / 173 cm		5-C7 7.5max
	-		2-B35 25max
	126 in / 320 cm		18-B35 40max
	186 in / 472 cm	AVL	110V, 220V



Chandelier		6817	
	(S)		(-40)
	62 lbs / 27.9 kg		-
	32 in / 81 cm		14-B10 60max
	55.5 in / 141 cm		-
	-		14-B35 40max
	126 in / 320 cm		-
	196 in / 498 cm	AVL	110V, 220V















Chandelier		6816	
	(S)		(-40)
	140 lbs / 63.0 kg		-
	48 in / 122 cm		30-B10 60max
	62 in / 157 cm		5-C7 7.5max
	-		2-B35 25max
	126 in / 320 cm		30-B35 40max
	192 in / 488 cm	AVL	110V, 220V, CCC















Chandelier		6815	
	(S)		(-40)
	80 lbs / 36.0 kg		-
	36 in / 91 cm		18-B10 60max
	52 in / 132 cm		5-C7 7.5max
	-		2-B35 25max
	84 in / 213 cm		18-B35 40max
	201 in / 511 cm	AVL	110V, 220V, CCC















Chandelier		6814	
 (S)	 (-40)		
 54 lbs / 24.3 kg	 -		
 32 in / 81 cm	 110	15-B10 60max	
 40 in / 102 cm	 110	-	
 -	 220	15-B35 40max	
 84 in / 213 cm	 220	-	
 148 in / 376 cm	AVL	110V, 220V, CCC	















Chandelier		6813	
 (S)	 (-211)		
 44 lbs / 19.8 kg	 -		
 30 in / 76 cm	 110	12-B10 60max	
 39 in / 99 cm	 110	-	
 -	 220	12-B35 40max	
 80 in / 203 cm	 220	-	
 149 in / 378 cm	AVL	110V, 220V	















Chandelier		6811	
 (S)	 (-40)		
 28 lbs / 12.6 kg	 -		
 25 in / 64 cm	 110	7-B10 60max	
 31 in / 79 cm	 110	-	
 -	 220	7-B35 40max	
 80 in / 203 cm	 220	-	
 156 in / 396 cm	AVL	110V, 220V	















Chandelier		6809	
 (S)	 (-40)		
 10 lbs / 4.5 kg	 -		
 11 in / 28 cm	 110	4-B10 40max	
 17 in / 43 cm	 110	-	
 -	 220	4-B35 40max	
 40 in / 102 cm	 220	-	
 129 in / 328 cm	AVL	110V, 220V	















Wall Sconce		6808	
	(S)		(-40)
	6 lbs / 2.7 kg		-
	14.5 in / 37 cm		3-B10 60max
	20 in / 51 cm		-
	7.5 in / 19 cm		3-B35 40max
	-		-
	-	AVL	110V, 220V















Wall Sconce		6807	
	(S)		(-40)
	5 lbs / 2.3 kg		-
	14.5 in / 37 cm		2-B10 60max
	16 in / 41 cm		-
	6 in / 15 cm		2-B35 40max
	-		-
	-	AVL	110V, 220V



Wall Sconce		6806	
	(S)		(-40)
	9 lbs / 4.1 kg		-
	18 in / 46 cm		5-B10 60max
	23 in / 58 cm		-
	9.5 in / 24 cm		5-B35 40max
	-		-
	-	AVL	110V, 220V



Wall Sconce		6805	
	(S)		(-40)
	2 lbs / 0.9 kg		-
	5 in / 13 cm		1-B10 60max
	15 in / 38 cm		-
	7.5 in / 19 cm		1-B35 40max
	-		-
	-	AVL	110V, 220V

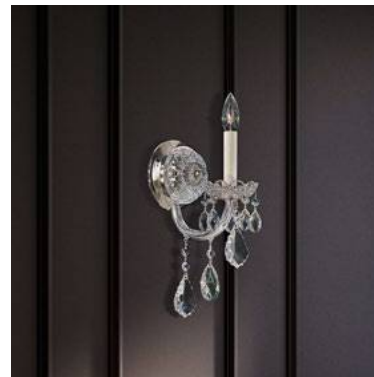

Petit Crystal

Inspired by the classical crystal basket designs of the chandeliers of the Empire era, which drew from the purity of neoclassical lines, Petit Crystal features a densely woven crystal surface that diffuses soft light on your interior.

* Product only available in 110V

Crystal Options

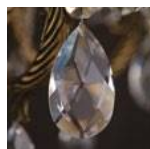

Spectra Crystal
(A)



Crystals from Swarovski
(S)

Finish Options



Polished Silver
(-40)







Heirloom Bronze
(-76)











Aurelia
(-211)





Close to Ceiling		1564	
	(A)		(-76)
	5 lbs / 2.3 kg		-

	14 in / 36 cm		5-G161/2 40max
	7.5 in / 19 cm		-
	-		-
	-		-
	-	AVL	110V



Close to Ceiling		1562	
	(A)		(-211)
	4 lbs / 1.8 kg		-

	12 in / 30 cm		5-G161/2 40max
	6.5 in / 17 cm		-
	-		-
	-		-
	-	AVL	110V



Close to Ceiling		1560	
	(A)		(-76)
	3 lbs / 1.4 kg		-

	10 in / 25 cm		4-G161/2 40max
	5.5 in / 14 cm		-
	-		-
	-		-
	-	AVL	110V



Close to Ceiling		1558	
	(A)		(-40)
	2 lbs / 0.9 kg		-

	8 in / 20 cm		3-G161/2 40max
	5.5 in / 14 cm		-
	-		-
	-		-
	-	AVL	110V



Petit Crystal Deluxe

Inspired by the classical crystal basket designs of the chandeliers of the Empire era, which drew from the purity of neoclassical lines, Petit Crystal features a densely woven crystal surface that diffuses soft light on your interior.

Crystal Options



Gemcut Crystal
(M)



Spectra Crystal
(A)



Crystals from Swarovski
(S)

Finish Options



Polished Silver
(-40)



Aurelia
(-211)

















Chandelier		6616	
	(A)		(-211)
	20 lbs / 9.0 kg		-

	21 in / 53 cm		16-B10 60max
	31 in / 79 cm		4-G161/2 60max
	-		16-B35 40max
	40 in / 102 cm		4-P45 40max
	153 in / 389 cm	AVL	110V, 220V, CCC



Chandelier		6618	
	(A)		(-40)
	22 lbs / 9.9 kg		-

	24 in / 61 cm		23-B10 60max
	34 in / 86 cm		-
	-		23-B35 40max
	40 in / 102 cm		-
	151 in / 384 cm	AVL	110V, 220V, CCC





Close to Ceiling		5898	
	(M)		(-40)
	49 lbs / 22.1 kg		-
	30.5 in / 77 cm		21-G161/2 40max
	15.5 in / 39 cm		-
	-		21-P45 40max
	-		-
	-	AVL	110V, 220V



Close to Ceiling		5897	
	(S)		(-211)
	190 lbs / 85.5 kg		-
	48 in / 122 cm		36-G161/2 25max
	21 in / 53 cm		-
	-		36-B35 40max
	-		-
	-	AVL	110V, 220V



Close to Ceiling		5896	
	(S)		(-211)
	125 lbs / 56.3 kg		-
	36 in / 91 cm		27-G161/2 25max
	17 in / 43 cm		-
	-		27-B35 40max
	-		-
	-	AVL	110V, 220V



Close to Ceiling		5895	
	(M)		(-40)
	24 lbs / 10.8 kg		-
	24 in / 61 cm		13-G161/2 25max
	12 in / 30 cm		-
	-		13-B35 40max
	-		-
	-	AVL	110V, 220V



Close to Ceiling		5894	
	(M)		(-211)
	13 lbs / 5.9 kg		-
	18 in / 46 cm		9-G161/2 40max
	10 in / 25 cm		-
	-		9-B35 40max
	-		-
	-	AVL	110V, 220V



Close to Ceiling		5893	
	(M)		(-211)
	7 lbs / 3.2 kg		-
	14 in / 36 cm		5-G161/2 40max
	8 in / 20 cm		-
	-		6-B35 40max
	-		-
	-	AVL	110V, 220V



Close to Ceiling		5892	
	(M)		(-40)
	6 lbs / 2.7 kg		-
	12 in / 30 cm		5-G161/2 40max
	8 in / 20 cm		-
	-		5-B35 40max
	-		-
	-	AVL	110V, 220V



















Close to Ceiling		5891	
	(M)		(-211)
	4 lbs / 1.8 kg		-
	10 in / 25 cm		4-G161/2 40max
	7 in / 18 cm		-
	-		4-P45 40max
	-		-
	-	AVL	110V, 220V



Close to Ceiling		5890	
	(M)		(-40)
	3 lbs / 1.4 kg		-
	8 in / 20 cm		3-G161/2 40max
	6 in / 15 cm		-
	-		3-B35 25max
	-		-
	-	AVL	110V, 220V



Close to Ceiling		6600	
 (A)	 (-211)		
	4 lbs / 1.8 kg		-

	10 in / 25 cm		3-G161/2 40max
	7.5 in / 19 cm		-
	5 in / 13 cm		3-P45 40max
	-		-
	-	AVL	110V, 220V

Plaza

Glitz, glamour and excess characterized the Hollywood Regency Style, which soared in the thirties with the great legends of cinema. Both lavish and contemporary, Plaza's Art Deco-inspired frames are studded with a splendid variety of clear or colored crystal shapes.

Canopy Options



110V*

*For 220V canopy information:
please contact customer service

Crystal Options



Spectra Crystal
(A)



Crystals from Swarovski
(S)



Crystals from Swarovski
Golden Shadow
(GS)

Finish Options







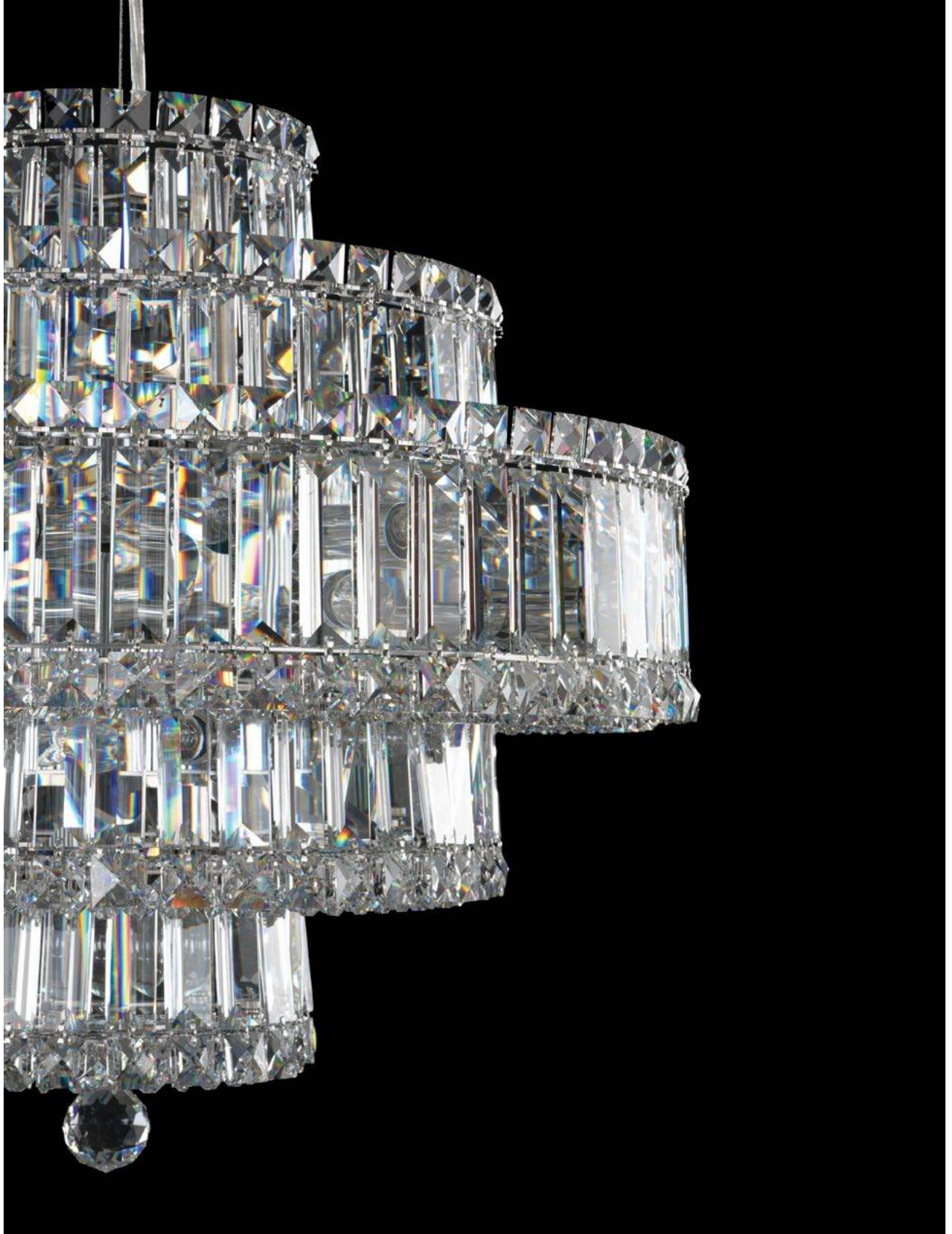







Polished
Stainless Steel
(-401)

































Pendant		6677	
 (S)	 (-401)		
		42 lbs / 18.9 kg	-

	27.5 in / 70 cm		31-B8 25max
	25 in / 64 cm		-
	-		31-B35 40max
	144 in / 366 cm		-
	144 in / 366 cm	AVL	110V, 220V















Pendant		6680	
	(A)		(-401)
	72 lbs / 32.4 kg		-
	48 in / 122 cm		24-G161/2 40max
	7 in / 18 cm		-
	22.5 in / 57 cm		24-P45 40max
	144 in / 366 cm		-
	144 in / 366 cm	AVL	110V, 220V, CCC



Pendant		6678	
	(A)		(-401)
	35 lbs / 15.8 kg		-
	34 in / 86 cm		16-G161/2 40max
	5 in / 13 cm		-
	16 in / 41 cm		15-B35 40max
	144 in / 366 cm		-
	144 in / 366 cm	AVL	110V, 220V, CCC



Pendant		6675	
	(GS)		(-401)
	36 lbs / 16.2 kg		-
	24.5 in / 62 cm		25-B8 40max
	25 in / 64 cm		-
	-		25-B35 40max
	144 in / 366 cm		-
	144 in / 366 cm	AVL	110V, 220V



Pendant		6674	
	(A)		(-401)
	34 lbs / 15.3 kg		-

	25 in / 64 cm		21-G161/2 40max
	6.5 in / 17 cm		-
	-		18-B35 40max
	144 in / 366 cm		-
	144 in / 366 cm	AVL	110V, 220V



Pendant		6673	
	(A)		(-401)
	24 lbs / 10.8 kg		-

	21 in / 53 cm		21-B8 40max
	19 in / 48 cm		1-G161/2 40max
	-		21-B35 40max
	144 in / 366 cm		1-P45 40max
	144 in / 366 cm	AVL	110V, 220V



Pendant		6672	
	(GS)		(-401)
	20 lbs / 9.0 kg		-

	21 in / 53 cm		15-G161/2 40max
	6.5 in / 17 cm		-
	-		15-B35 40max
	144 in / 366 cm		-
	144 in / 366 cm	AVL	110V, 220V





Pendant		6671	
	(S)		(-401)
	10 lbs / 4.5 kg		-
	14.5 in / 37 cm		9-B8 40max
	13 in / 33 cm		-
	-		9-P45 40max
	144 in / 366 cm		-
	144 in / 366 cm	AVL	110V, 220V



Pendant		6670	
	(A)		(-401)
	8 lbs / 3.6 kg		-
	14.5 in / 37 cm		9-G161/2 40max
	6.5 in / 17 cm		-
	-		8-B35 40max
	144 in / 366 cm		-
	144 in / 366 cm	AVL	110V, 220V



Close to Ceiling		6694	
	(GS)		(-401)
	11 lbs / 5.0 kg		-
	12 in / 30 cm		4-G9 40max
	7.5 in / 19 cm		-
	-		4-G9 40max
	-		-
	-	AVL	110V, 220V



Close to Ceiling		6692	
	(S)		(-401)
	9 lbs / 4.1 kg		-
	10 in / 25 cm		4-G9 40max
	7.5 in / 19 cm		-
	-		4-G9 40max
	-		-
	-	AVL	110V, 220V



Close to Ceiling		6690	
	(A)		(-401)
	6 lbs / 2.7 kg		-
	8 in / 20 cm		4-G9 40max
	7 in / 18 cm		-
	-		4-G9 40max
	-		-
	-	AVL	110V, 220V



Renaissance

Recalling the glorious opulence of Baroque chandeliers with its open frame, lyre patterns and bouquet tops, Renaissance is an homage to the seventeenth-century court of King Louis XIV. Our interpretation is boldly contemporary.

Crystal Options



Heritage Crystal
(H)



Crystals from Swarovski
(S)



Crystals from Swarovski
Golden Teak (TK)

Finish Options



Heirloom Gold
(-22)



Etruscan Gold
(-23)



French Gold
(-26)



Antique Silver
(-48)



Black
(-51)















Heirloom Bronze
(-76)







Chandelier		3773	
 (H)	 (-51)		 -
		93 lbs / 41.9 kg	-

	38 in / 97 cm		15-B10 60max
	44 in / 112 cm		1-T7 15max
	-		15-B35 40max
	84 in / 213 cm		-
	130 in / 330 cm	AVL	110V, 220V, CCC



Chandelier		3796	
	(S)		(-76)
	56 lbs / 25.5 kg		-
	22 in / 56 cm		14-B10 60max
	34 in / 86 cm		-
	56 in / 142 cm		14-B35 40max
	40 in / 102 cm		-
	140 in / 356 cm	AVL	110V, 220V



Chandelier		3795	
	(H)		(-22)
	46 lbs / 21 kg		-
	22 in / 56 cm		12-B10 60max
	33.5 in / 85 cm		-
	46.5 in / 118 cm		12-B35 40max
	40 in / 102 cm		-
	140 in / 356 cm	AVL	110V, 220V



Chandelier		3792	
	(H)		(-76)
	82 lbs / 36.9 kg		-

	40 in / 102 cm		18-B10 60max
	28 in / 71 cm		1-T7 15max
	-		18-B35 40max
	84 in / 213 cm		-
	152 in / 386 cm	AVL	110V, 220V, CCC



Chandelier		3790	
	(H)		(-51)
	50 lbs / 22.5 kg		-

	33 in / 84 cm		12-B10 60max
	26 in / 66 cm		1-T7 15max
	-		12-B35 40max
	40 in / 102 cm		-
	147 in / 373 cm	AVL	110V, 220V, CCC



Chandelier		3787	
	(H)		(-23)
	37 lbs / 16.7 kg		-

	26.5 in / 67 cm		8-B10 60max
	35 in / 89 cm		-
	-		8-B35 40max
	40 in / 102 cm		-
	132 in / 335 cm	AVL	110V, 220V, CCC





Chandelier		3783	
	(H)		(-48)
	124 lbs / 55.8 kg		-
	36 in / 91 cm		24-B10 60max
	72 in / 183 cm		1-T7 15max
	-		24-B35 40max
	126 in / 320 cm		-
	166 in / 422 cm	AVL	110V, 220V, CCC



Chandelier		3780	
	(H)		(-51)
	38 lbs / 17.1 kg		-
	21 in / 53 cm		9-B10 60max
	40 in / 102 cm		1-T7 15max
	-		9-B35 40max
	120 in / 305 cm		-
	169 in / 429 cm	AVL	110V, 220V, CCC



Chandelier		3774	
	(H)		(-22)
	137 lbs / 61.7 kg		-
	45 in / 114 cm		24-B10 60max
	52 in / 132 cm		1-T7 15max
	-		24-B35 40max
	84 in / 213 cm		-
	223 in / 566 cm	AVL	110V, 220V, CCC



Chandelier		3772	
	(H)		(-22)
	60 lbs / 27.0 kg		-
	32 in / 81 cm		12-B10 60max
	37 in / 94 cm		1-T7 15max
	-		12-B35 40max
	84 in / 213 cm		-
	130 in / 330 cm	AVL	110V, 220V, CCC



Chandelier		3771	
	(TK)		(-76)
	40 lbs / 18.0 kg		-
	26.5 in / 67 cm		8-B10 60max
	32 in / 81 cm		1-T7 15max
	-		8-B35 40max
	40 in / 102 cm		-
	133 in / 338 cm	AVL	110V, 220V, CCC







Chandelier		3770	
	(H)		(-48)
	29 lbs / 13.1 kg		-
	23.5 in / 60 cm		6-B10 60max
	27 in / 69 cm		1-T7 15max
	-		6-B35 40max
	40 in / 102 cm		-
	132 in / 335 cm	AVL	110V, 220V











Chandelier		3769	
	(H)		(-76)
	10 lbs / 4.5 kg		-
	14.5 in / 37 cm		5-B10 60max
	19 in / 48 cm		-
	-		5-B35 40max
	40 in / 102 cm		-
	126 in / 320 cm	AVL	110V, 220V, CCC

















Close to Ceiling		3785	
	(H)		(-51)
	30 lbs / 13.5 kg		-

	26 in / 66 cm		8-B10 40max
	18 in / 46 cm		-
	-		8-B35 40max
	-		-
	-	AVL	110V, 220V



Close to Ceiling		3784	
	(H)		(-22)
	18 lbs / 8.1 kg		-

	20 in / 51 cm		6-B10 40max
	16 in / 41 cm		-
	-		3-GU10 35max, Incl.
	-		-
	-	AVL	110V, 220V



Wall Sconce		3762	
	(H)		(-48)
	8 lbs / 3.6 kg		-
	15 in / 38 cm		3-B10 60max
	22 in / 56 cm		-
	8 in / 20 cm		3-B35 40max
	-		-
	-	AVL	110V, 220V



Wall Sconce		3761	
	(H)		(-22)
	8 lbs / 3.6 kg		-
	15 in / 38 cm		2-B10 60max
	22.5 in / 57 cm		-
	8 in / 20 cm		2-B35 40max
	-		-
	-	AVL	110V, 220V



Wall Sconce		3758	
	(H)		(-48)
	5 lbs / 2.3 kg		-
	14 in / 36 cm		2-B10 60max
	22.5 in / 57 cm		-
	4.5 in / 11 cm		2-B35 40max
	-		-
	-	AVL	110V, 220V



Wall Sconce		3756	
	(H)		(-48)
	3.5 lbs / 1.6 kg		-
	6 in / 15 cm		1-B10 60max
	15.5 in / 39 cm		-
	5.5 in / 14 cm		1-B35 40max
	-		-
	-	AVL	110V, 220V



Renaissance Rock Crystal

The delightful play of rock crystal gemstones with clear and colored drops transform our Renaissance chandelier into a unique collectible. Its ornate framework, featuring authentic seventeenth-century styling, marries the sensual curves of precious metals with the luminosity of intricately cut glass.

Crystal Options



Rock Crystal: Heritage Clear (CL)



Rock Crystal: Heritage Clear Amethyst & Black Diamond (AD)



Rock Crystal: Heritage Clear Olivine & Smoke (OS)

Finish Options



Heirloom Gold (-22)



Etruscan Gold (-23)



French Gold (-26)



Antique Pewter (-47)



Antique Silver (-48)



Black (-51)

















Heirloom Bronze (-76)



















Chandelier		3573	
 (CL)	 (-47)		
 80 lbs / 36.0 kg	 -		





 38 in / 97 cm	 15-B10 60max
 44 in / 112 cm	 1-T7 15max
 -	 15-B35 40max
 84 in / 213 cm	 -
 130 in / 330 cm	 AVL 110V, 220V, CCC











Chandelier		3587	
	(OS)		(-23)
	37 lbs / 16.7 kg		-





	26.5 in / 67 cm		8-B10 60max
	35 in / 89 cm		-
	-		8-B35 40max
	40 in / 102 cm		-
	132 in / 335 cm	AVL	110V, 220V, CCC











Chandelier		3572	
	(CL)		(-76)
	58 lbs / 26.1 kg		-

	32 in / 81 cm		12-B10 60max
	40 in / 102 cm		1-T7 15max
	-		12-B35 40max
	84 in / 213 cm		-
	130 in / 330 cm	AVL	110V, 220V, CCC



Close to Ceiling		3584	
 (AD)	 (-22)		
 16 lbs / 7.2 kg	 -		

	20 in / 51 cm		6-B10 40max
	16 in / 41 cm		-
	-		6-B35 40max
	-		-
	-	AVL	110V, 220V

Rivendell

A bouquet of finely crafted metal encrusted with tiny crystal jewels, blooming into a melody of delicate leaves and flowers. Rivendell is a collectible and a signature design of the Schonbek house. This timeless, feminine design is a lovely addition to a boudoir, foyer or even to contrast with a modern, minimalist space.

Canopy Options



110V*

*For 220V canopy information: please contact customer service

Crystal Options

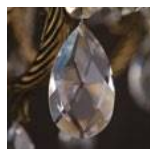

Spectra Crystal (A)



Crystals from Swarovski (S)

Finish Options



Heirloom Gold (-22)



Etruscan Gold (-23)



French Gold (-26)



Antique Silver (-48)

















Heirloom Bronze (-76)







Chandelier		7864	
 (S)	 (-23)		 -
	23 lbs / 10.4 kg		-

	32 in / 81 cm		16-G161/2 60max
	27 in / 69 cm		-
	-		16-P45 40max
	80 in / 203 cm		-
	122 in / 310 cm	AVL	110V, 220V, CCC



Chandelier		7882	
◊ (A)		○ (-26)	
⊙ 12 lbs / 5.4 kg		☀ -	
↔ 20 in / 51 cm		💡 ₁₁₀	3-C7 7.5max
↑↓ 22.5 in / 57 cm		💡 ₁₁₀	5-G161/2 60max
↘ -		💡 ₂₂₀	8-P45 40max
↓ 40 in / 102 cm		💡 ₂₂₀	-
🌀 126 in / 320 cm		AVL	110V, 220V, CCC















Chandelier		7866	
◊ (S)		○ (-48)	
⊙ 13 lbs / 5.9 kg		☀ -	
↔ 26 in / 66 cm		💡 ₁₁₀	8-B10 60max
↑↓ 23 in / 58 cm		💡 ₁₁₀	-
↘ -		💡 ₂₂₀	8-B35 40max
↓ 40 in / 102 cm		💡 ₂₂₀	-
🌀 125 in / 318 cm		AVL	110V, 220V, CCC



Chandelier		7863	
◊ (A)		○ (-76)	
⊙ 14.5 lbs / 6.5 kg		☀ -	
↔ 26 in / 66 cm		💡 ₁₁₀	8-G161/2 60max
↑↓ 23 in / 58 cm		💡 ₁₁₀	-
↘ -		💡 ₂₂₀	8-P45 40max
↓ 40 in / 102 cm		💡 ₂₂₀	-
🌀 125 in / 318 cm		AVL	110V, 220V, CCC



Wall Sconce		7855	
 (S)	 (-48)		
 3 lbs / 1.4 kg	 -		

	12 in / 30 cm		2-G161/2 40max
	10 in / 25 cm		-
	5,5 in / 14 cm		2-P45 40max
	-		-
	-	AVL	110V, 220V

Sarella

A waterfall of metal discs and crystal beading glimmers around fine glass arms. Sarella's classic marriage of hand-finished metal and multifaceted crystal drops sheds a beautiful, soft light on your interior. An instant heirloom, it has been interpreted in different styles, from the traditional frame enhanced by round branches, to the simple bejeweled columns perfect for intimate areas.

Canopy Options



110V



220V



220V

Crystal Options



Heritage Crystal
(H)



Spectra Crystal
(A)



Crystals from Swarovski
(S)

Finish Options



White
(-06)



Heirloom Gold
(-22)



Antique Silver
(-48)

















Polished
Stainless Steel
(-401)







Chandelier		RS8415	
 (A)	 (-401)		-
	44 lbs / 19.8 kg		-

	40.5 in / 103 cm		17-B10 60max
	50.5 in / 128 cm		-
	-		17-B35 40max
	80 in / 203 cm		-
	141 in / 358 cm	AVL	110V, 220V



Chandelier		RS84151	
	(A)		(-401)
	41 lbs / 18.6 kg		-
	40.5 in / 103 cm		17-B10 60max
	50.5 in / 128 cm		-
	-		17-B35 40max
	80 in / 203 cm		-
	141 in / 358 cm	AVL	110V, 220V



Chandelier		RS8315	
	(A)		(-401)
	41 lbs / 18.5 kg		-
	41 in / 104 cm		15-B10 60max
	35 in / 89 cm		-
	-		15-B35 40max
	80 in / 203 cm		-
	154 in / 391 cm	AVL	110V, 220V



Chandelier		RS8310	
	(S)		(-401)
	28 lbs / 12.6 kg		-

	40.5 in / 103 cm		10-B10 60max
	30 in / 76 cm		-
	24.5 in / 62 cm		10-B35 40max
	51 in / 130 cm		-
	120 in / 305 cm	AVL	110V, 220V



Chandelier		RS83151	
	(A)		(-401)
	39 lbs / 17.7 kg		

	41 in / 104 cm		15-B10 60max
	35 in / 89 cm		-
	-		15-B35 40max
	80 in / 203 cm		-
	154 in / 391 cm	AVL	110V, 220V



Chandelier		RS83101	
	(S)		(-401)
	26 lbs / 11.8 kg		

	40.5 in / 103 cm		10-B10 60max
	30 in / 76 cm		-
	24.5 in / 62 cm		10-B35 40max
	51 in / 130 cm		-
	120 in / 305 cm	AVL	110V, 220V





Chandelier		RS83081	
	(S)		(-22)
	23 lbs / 10.4 kg		





	30 in / 76 cm		8-B10 60max
	31 in / 79 cm		-
	-		8-B35 40max
	40 in / 102 cm		-
	120 in / 305 cm	AVL	110V, 220V











Chandelier		RS83061	
	(H)		(-48)
	14 lbs / 6.35 kg		





	24.5 in / 62 cm		6-B10 60max
	23.5 in / 60 cm		-
	-		6-B35 40max
	40 in / 102 cm		-
	124 in / 315 cm	AVL	110V, 220V











Pendant		RS8352	
 (A)	 (-401)		
 23 lbs / 10.4 kg	 -		







 47.5 in / 121 cm	 110	11-G16-1/2 40max	
 5.5 in / 14 cm	 110 ^{max}	-	
 5 in / 13 cm	 250	11-P45 40max	
 144 in / 366 cm	 250 ^{max}	-	
 140 in / 356 cm	AVL	110V, 220V, CCC	









Pendant		RS8351	
 (A)	 (-22)		
 91 lbs / 41.0 kg	 -		



 59 in / 150 cm	 110	32-B10 60max	
 10 in / 25 cm	 110 ^{max}	-	
 -	 250	32-B35 40max	
 144 in / 366 cm	 250 ^{max}	-	
 140 in / 356 cm	AVL	110V, 220V	

Pendant		RS8350	
 (H)	 (-22)		
 61 lbs / 28 kg	 -		



 48 in / 122 cm	 110	27-B10 60max	
 8 in / 20 cm	 110 ^{max}	-	
 -	 250	27-B35 40max	
 144 in / 366 cm	 250 ^{max}	-	
 140 in / 356 cm	AVL	110V, 220V	



Pendant		RS8349	
	(H)		(-401)
	51 lbs / 23 kg		-
	36 in / 92cm		18-B10 60max
	8 in / 20 cm		-
	-		18-P45 40max
	144 in / 366 cm		-
	140 in / 356 cm	AVL	110V, 220V



Pendant		RS8346	
	(A)		(-48)
	21 lbs / 9.5 kg		-
	32.5 in / 83 cm		7-G161/2 40max
	8 in / 20 cm		-
	14in /		7-P45 40max
	144 in / 366 cm		-
	140 in / 356 cm	AVL	110V, 220V

















Pendant		RS8345	
	(H)		(-401)
	18 lbs / 8.1 kg		-
	15.5 in / 39 cm		4 B10 40max
	10 in / 25 cm		-
	-		3-GU10 35max, Incl.
	144 in / 366 cm		-
	140 in / 25 cm	AVL	110V









Pendant		RS8344	
	(S)		(-22)
	27 lbs / 12.2 kg		-
	36.5 in / 93 cm		13-G161/2 40max
	8 in / 20 cm		-
	12 in / 30 cm		13-P45 40max
	144 in / 366 cm		-
	144 in / 366 cm	AVL	110V, 220V











Pendant		RS8343	
 (A)	 (-22)		 -
	24 lbs / 10.8 kg		-







	24 in / 61 cm		12-G161/2 40max
	5.5 in / 14 cm		-
	-		12-P45 40max
	144 in / 366 cm		-
	144 in / 366 cm	AVL	110V, 220V











Pendant		RS8341	
 (S)	 (-48)		 -
	4 lbs / 1.8 kg		-

	5 in / 13 cm		3-B10 40max
	15 in / 38 cm		-
	-		3-B35 40max
	144 in / 366 cm		-
	144 in / 366 cm	AVL	110V, 220V















Pendant		RS8340	
 (A)	 (-401)		 -
	29 lbs / 13.1 kg		-













	36 in / 91 cm		12-G161/2 40max
	10 in / 25 cm		-
	12 in / 30 cm		12-P45 40max
	144 in / 366 cm		-
	144 in / 366 cm	AVL	110V, 220V











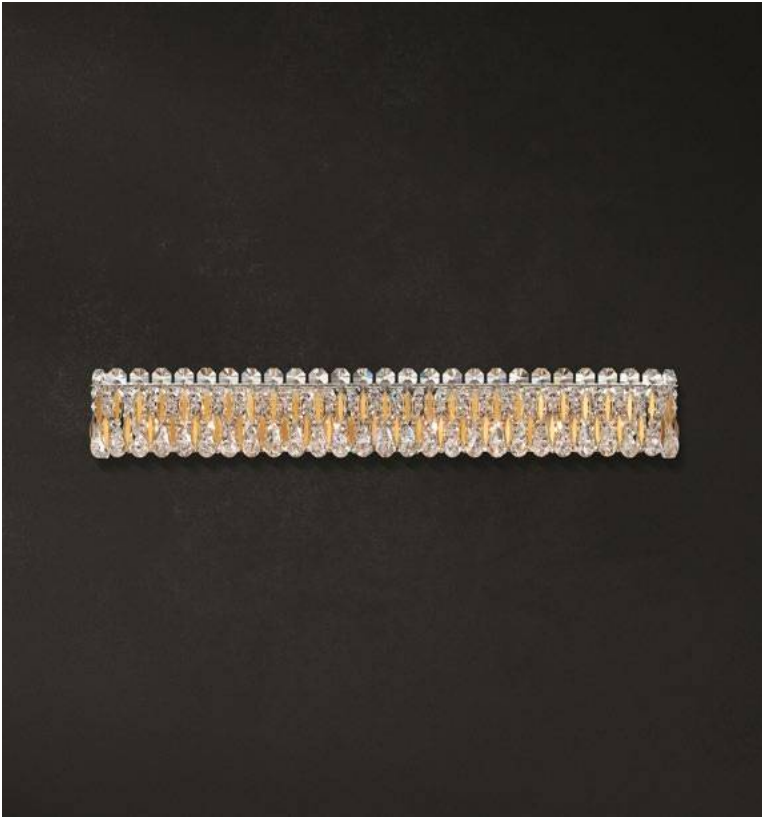







Close to Ceiling		RS8348	
	(S)		(-48)
	15 lbs / 6.8 kg		-
	15.5 in / 39 cm		3-B10 40max
	6.5 in / 17 cm		-
	-		3-GU10 35max, Incl.
	-		-
	-	AVL	110V, 220V







Close to Ceiling		RS8347	
	(A)		(-06)
	37 lbs / 17 kg		-
	24 in / 61 cm		12-B10 40max
	7.5 in / 19 cm		-
	-		12-B35 40max
	-		-
	-	AVL	110V, 220V











Wall Sconce		RS8336	
	(H)		(-22)
	16 lbs / 7.2 kg		-

	36.5 in / 93 cm		8-G161/2 40max
	5.5 in / 14 cm		-
	5 in / 13 cm		8-P45 40max
	-		-
	-	AVL	110V, 220V



Wall Sconce		RS8333	
	(A)		(-401)
	4 lbs / 1.8 kg		-

	7 in / 18 cm		2-G161/2 40max
	11 in / 28 cm		-
	5 in / 13 cm		2-P45 40max
	-		-
	-	AVL	110V, 220V



Wall Sconce		RS8332	
	(S)		(-22)
	7 lbs / 3.2 kg		-
	16 in / 41 cm		2-B10 60max
	23 in / 58 cm		-
	10 in / 25 cm		2-B35 40max
	-		-
	-	AVL	110V, 220V















Wall Sconce		RS8331	
	(S)		(-401)
	6 lbs / 2.7 kg		-
	7 in / 18 cm		4-B10 60max
	22 in / 56 cm		-
	4 in / 10 cm		4-B35 40max
	-		-
	-	AVL	110V, 220V



Wall Sconce		RS8324	
	(S)		(-06)
	12 lbs / 5.4 kg		-
	25.5 in / 65 cm		6-G161/2 40max
	5.5 in / 14 cm		-
	5 in / 13 cm		6-P45 40max
	-		-
	-	AVL	110V, 220V



Table Lamp		RS8301	
 (S)	 (-22)	 5 lbs / 2.3 kg	 -

	5.5 in / 14 cm		11 lbs / 5 kg
	22 in / 56 cm		-
	-		3-G9 40m
	-		-
	-	AVL	110V, 220V

Savannah

With beautifully detailed glass arms, exquisitely faceted large crystals in various shapes, and elongated candle slips, Savannah celebrates the timeless romance of the chandelier. Wall sconces express the same elegance with a single long tiered crystal pendant balancing the height of the candle slip. Savannah always complements her hostess, elevating the tenor of traditional, contemporary, and eclectic interiors.

Crystal Options



Heritage Crystal
(H)

Finish Options



Heirloom Gold
(-22)



Polished Silver
(-40)



Black
(-51)

















Chandelier		CF1006	
	(H)		(-40)
	15.4 lbs / 7 kg		-

	26 in / 64 cm		6-B10 40max
	24 in / 60 cm		-
	-		6-B10 40max
	40 in / 102 cm		-
	120 in / 305 cm	AVL	110V, 220V



Wall Sconce		CF1001	
	(H)		(-51)
	2 lbs / .9 kg		-

	7 in / 618 cm		1-B10 40max
	15 in / 38 cm		-
	5 in / 13 cm		1-B10 40max
	-		-
	-	AVL	110V, 220V

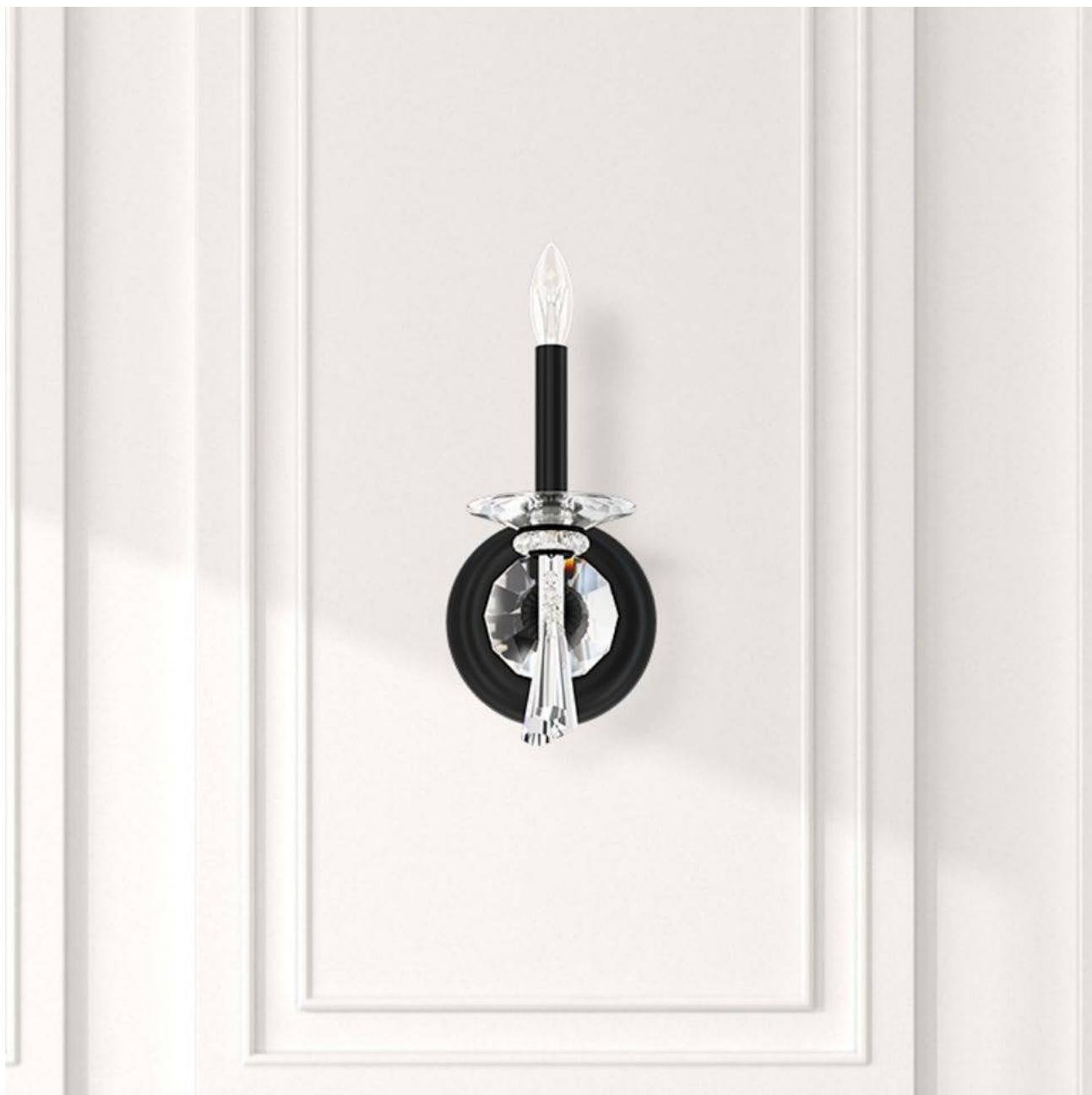

Sonatina

Like playful notes rising and falling in a Baroque Sonata, a flight of delicate crystals dance around the graceful, handcrafted glass and metal column of this chandelier. These palatial designs dazzle in stately lobbies and ballrooms, and in your own plush entertainment areas.

Canopy Options



110V

* Product only available in 110V

Crystal Options



Heritage Crystal (H)



Crystals from Swarovski (S)

Finish Options



Heirloom Gold (-22)



Etruscan Gold (-23)



French Gold (-26)



Polished Silver (-40)



Antique Silver (-48)



Black Pearl (-49)



Heirloom Bronze (-76)

















Aurelia (-211)







Chandelier		ST1952	
 (S)	 (-40)		
	48 lbs / 21.6 kg		-

	35 in / 89 cm		14-B10 60max
	52.5 in / 133 cm		-
	-		-
	120 in / 305 cm		-
	194 in / 493 cm	AVL	110V



Chandelier		ST1946	
	(H)		(-211)
	25 lbs / 11.3 kg		-

	25.5 in / 65 cm		10-B10 60max
	29.5 in / 75 cm		-
	-		-
	40 in / 102 cm		-
	154 in / 391 cm	AVL	110V



Chandelier		ST1852	
	(H)		(-76)
	35 lbs / 15.8 kg		-





	35 in / 89 cm		14-B10 60max
	39 in / 99 cm		-
	-		-
	80 in / 203 cm		-
	148 in / 375 cm	AVL	110V











Chandelier		ST1849	
	(H)		(-40)
	30 lbs / 13.5 kg		-

	34 in / 86 cm		12-B10 60max
	29.5 in / 75 cm		-
	-		-
	40 in / 102 cm		-
	156 in / 395 cm	AVL	110V



Wall Sconce		ST1939	
	(S)		(-48)
	3 lbs / 1.4 kg		-

	12.5 in / 32 cm		2-B10 60max
	17 in / 43 cm		-
	5.5 in / 14 cm		-
	-		-
	-	AVL	110V

Sophia

The Rococco frame of Sophia, entirely cast in Italy for Schonbek, features elaborately etched precious metals forming an open-cage design. Rich crystal adornments add a royal allure to this true heirloom piece.

* Product only available in 110V

Crystal Options



Optic Crystal
(O)



Spectra Crystal
(A)



Crystals from Swarovski
(S)



Crystals from Swarovski
Golden Shadow
(GS)



Crystals from Swarovski
Golden Teak
(TK)



Crystals from Swarovski
Silver Shade
(SH)

Finish Options



Heirloom Gold
(-22)



Etruscan Gold
(-23)



French Gold
(-26)



Parchment Gold
(-27)



Antique Silver
(-48)



Parchment
Bronze
(-74)



Heirloom Bronze
(-76)



Roman Silver
(-80)







Floretine Bronze
(-83)











Midnight Gild
(-86)





Chandelier		6967	
	(A)		(-83)
	180 lbs / 81.0 kg		-

	55 in / 140 cm		35-B10 60max
	63 in / 160 cm		-
	-		-
	126 in / 320 cm		-
	169 in / 429 cm	AVL	110V



Chandelier		6952	
	(SH)		(-48)
	55 lbs / 24.8 kg		-
	39 in / 99 cm		12-B10 60max
	33 in / 84 cm		-
	-		-
	84 in / 213 cm		-
	134 in / 340 cm	AVL	110V



Chandelier		6949	
	(SH)		(-80)
	25.5 lbs / 11.5 kg		-
	28 in / 71 cm		9-B10 60max
	30 in / 76 cm		-
	-		-
	40 in / 102 cm		-
	135 in / 343 cm	AVL	110V

Southampton

Glamorous and fluid yet also tailored and geometrically precise, Southampton is traditional elegance with a twist. Crystal-beaded chains suspended from a halo of slim metal tubing create a symmetrical curtain. A cluster of seeded glass globes of varying sizes is set at the midpoint between the halo and the curtain. Light refracted through Southampton's crystals has a lively quality that feels particularly apt for social spaces like living and dining rooms.

Crystal Options



Heritage Crystal
(H)





Finish Options











Heirloom Silver
(-B44)

















Pendant		WM1008	
	(H)		(-B44)
	18.7 lbs / 8.5 kg		-

	Ø 24in / Ø 618,5 cm		6-B10 40max
	55in / 139.7cm		-
	-		6-B10 40max
	42in / 106.8 cm - Rod		-
	122 in / 310cm	AVL	110V, 220V



Pendant		WM1006	
	(H)		(-B44)
	14.3 lbs / 6.5 kg		-

	Ø 20 in / Ø 51.6 cm		6-B10 40max
	47.0 in / 119.4cm		-
	-		6-B10 40max
	42in / 106.8 cm - Rod		-
	122 in / 310cm	AVL	110V, 220V



Sterling

In the eighteenth century advances in glassmaking techniques and the demands of rich patrons made all-glass chandeliers the ultimate statement of class. Sterling, an all-crystal chandelier with hand-formed crystal arms and finely cut pendants, column and dishes, is the ultimate illustration of historical chandeliers' 'dazzling by light.'

Crystal Options



Heritage Crystal
(H)



Crystals from Swarovski
(S)

Finish Options



Polished Silver
(-40)















Aurelia
(-211)







Chandelier		3612	
 (H)	 (-40)		176 lbs / 79.2 kg
			-

	60 in / 152 cm		40-B10 60max
	76 in / 193 cm		5-B8 25max
	-		3-B35 25max
	126 in / 320 cm		40-B35 40max
	160 in / 406 cm	AVL	110V, 220V



Chandelier		3610	
	(H)		(-40)
	70 lbs / 31.5 kg		-
	45 in / 114 cm		25-B10 60max
	61 in / 155 cm		-
	-		25-B35 40max
	84 in / 213 cm		-
	209 in / 531 cm	AVL	110V, 220V



Chandelier		3608	
	(H)		(-40)
	40 lbs / 18.0 kg		-
	32 in / 81 cm		15-B10 60max
	47 in / 119 cm		-
	-		15-B35 40max
	80 in / 203 cm		-
	149 in / 378 cm	AVL	110V, 220V



Chandelier		3601	
	(S)		(-40)
	26 lbs / 11.7 kg		-
	29 in / 74 cm		12-B10 60max
	30 in / 76 cm		-
	-		12-B35 40max
	40 in / 102 cm		-
	120 in / 305 cm	AVL	110V, 220V



Chandelier		2999	
	(H)		(-211)
	10 lbs / 4.5 kg		-
	16 in / 41 cm		5-B10 60max
	18 in / 46 cm		-
	-		5-B35 40max
	40 in / 102 cm		-
	127 in / 323 cm	AVL	110V, 220V



Chandelier		2998	
	(H)		(-40)
	54 lbs / 24.3 kg		-

	34 in / 86 cm		20-B10 60max
	43 in / 109 cm		-
	-		20-B35 40max
	126 in / 320 cm		-
	146 in / 371 cm	AVL	110V, 220V, CCC



Chandelier		2997	
	(S)		(-40)
	32 lbs / 14.4 kg		-

	29 in / 74 cm		12-B10 60max
	38 in / 97 cm		-
	-		12-B35 40max
	40 in / 102 cm		-
	149 in / 378 cm	AVL	110V, 220V















Chandelier		2996	
	(H)		(-40)
	24 lbs / 10.8 kg		-

	27 in / 69 cm		9-B10 60max
	31 in / 79 cm		-
	-		9-B35 40max
	40 in / 102 cm		-
	152 in / 386 cm	AVL	110V, 220V, CCC

















Chandelier		2995	
	(H)		(-211)
	16 lbs / 7.2 kg		-





	25 in / 64 cm		7-B10 60max
	26 in / 66 cm		-
	-		7-B35 40max
	40 in / 102 cm		-
	121 in / 307 cm	AVL	110V, 220V, CCC











Chandelier		2994	
	(H)		(-40)
	12 lbs / 5.4 kg		-





	21 in / 53 cm		6-B10 60max
	22.5 in / 57 cm		-
	-		6-B35 40max
	40 in / 102 cm		-
	124 in / 315 cm	AVL	110V, 220V











Wall Sconce		2992	
	(S)		(-40)
	5 lbs / 2.3 kg		-





	15.5 in / 39 cm		3-B10 60max
	21 in / 53 cm		-
	7.5 in / 19 cm		3-B35 40max
	-		-
	-	AVL	110V, 220V, CCC











Wall Sconce		2991	
	(S)		(-211)
	4 lbs / 1.8 kg		-

	10.5 in / 27 cm		2-B10 60max
	16.5 in / 42 cm		-
	6.5 in / 17 cm		2-B35 40max
	-		-
	-	AVL	110V, 220V, CCC



Wall Sconce		2990	
	(A)		(-40)
	2 lbs / 0.9 kg		-

	5 in / 13 cm		1-B10 60max
	15 in / 38 cm		-
	8 in / 20 cm		1-B35 40max
	-		-
	-	AVL	110V, 220V



Tiara

Inspired by the bejeweled coronets worn by the ladies of nobility, Tiara is an original Schonbek design. Its sophisticated lace-like frame is adorned with tiny crystal beads, as if sparkling from within. The basket of crystals falling from the crown recalls the lines of Empire-style chandeliers while creating a timeless majestic feel.

* Product only available in 110V

Crystal Options



Spectra Crystal
(A)

Finish Options



Heirloom Gold
(-22)



Etruscan Gold
(-23)



French Gold
(-26)



Antique Silver
(-48)



Jet Black
(-55)



Heirloom Bronze
(-76)





Close to Ceiling		9845	
	(A)		(-26)
	22 lbs / 9.9 kg		-

	30 in / 76 cm		17-B10 60max
	19.5 in / 50 cm		-
	-		17-B35 40max
	-		-
	-	AVL	110V



Close to Ceiling		9843	
	(A)		(-48)
	9 lbs / 4.1 kg		-

	20 in / 51 cm		6-B10 60max
	13.5 in / 34 cm		3-G161/2 60max
	-		6-B35 40max
	-		3-P45 40max
	-	AVL	110V



Close to Ceiling		9841	
	(A)		(-22)
	5 lbs / 2.3 kg		-

	15 in / 38 cm		5-G161/2 60max
	10.5 in / 27 cm		-
	-		4-P45 40max
	-		-
	-	AVL	110V

Triandra

With its nature-inspired combination of crystal and metal, Triandra embodies the trend towards organic, holistic interior spaces. Handcrafted metal formed into willow tree leaves are punctuated with tiny crystal octagons, creating multi-layered depth as they cascade down the center column of the chandelier. Two circles of brilliantly faceted prisms unite the column on the top and bottom, drawing the eye and imagination inward to celebrate natural beauty and create harmony within the home.

Canopy Options



110V

* Product only available in 110V

Crystal Options

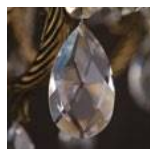

Spectra Crystal
(A)



Crystals from Swarovski
(S)

Finish Options



White
(-06)



Heirloom Gold
(-22)



Antique Silver
(-48)















Heirloom Bronze
(-76)







Polished
Stainless Steel
(-401)

















Pendant		LR1010			18.5 in / 47 cm		7-B10 40max
					26 in / 66 cm		-
	(A)		(-22)		-		-
	20 lbs / 9 kg		-		40 in / 102 cm		-
					125 in / 318 cm	AVL	110V











Pendant		LR1008	
	(A)		(-06)
	9 lbs / 4.1 kg		-

	10.5 in / 27 cm		3-B10 40max
	15 in / 38 cm		-
	-		-
	40 in / 102 cm		-
	140 in / 356 cm	AVL	110V















Pendant		LR1006	
	(A)		(-401)
	5 lbs / 2.3 kg		-

	7 in / 18 cm		1-B10 40 max
	10.5 in / 27 cm		-
	-		-
	40 in / 102 cm		-
	140 in / 356 cm	AVL	110V

















Close to Ceiling		LR1004	
	(A)		(-48)
	10 lbs / 4.5 kg		-

	18.75 in / 48 cm		5-B10 40max
	15 in / 38 cm		-
	-		-
	-		-
	-	AVL	110V



Wall Sconce		LR1002	
	(H)		(-22)
	8 lbs / 3.6 kg		-

	16 in / 41 cm		3-B10 40max
	10 in / 25 cm		-
	5 in / 13 cm		-
	-		-
	-	AVL	110V



Trilliane

A signature Schonbek chandelier, Trilliane blends the grandeur of Antiquity with the opulence of an all-crystal masterpiece. Glimmering with inverted pendeloques, it is created using a historically revolutionary technique that evokes the rawness of mineral crystal.

Canopy Options



110V*

*For 220V canopy information:
please contact customer service

Crystal Options



Spectra Crystal
(A)



Crystals from Swarovski
(S)

Finish Options

















Polished Silver
(-40)











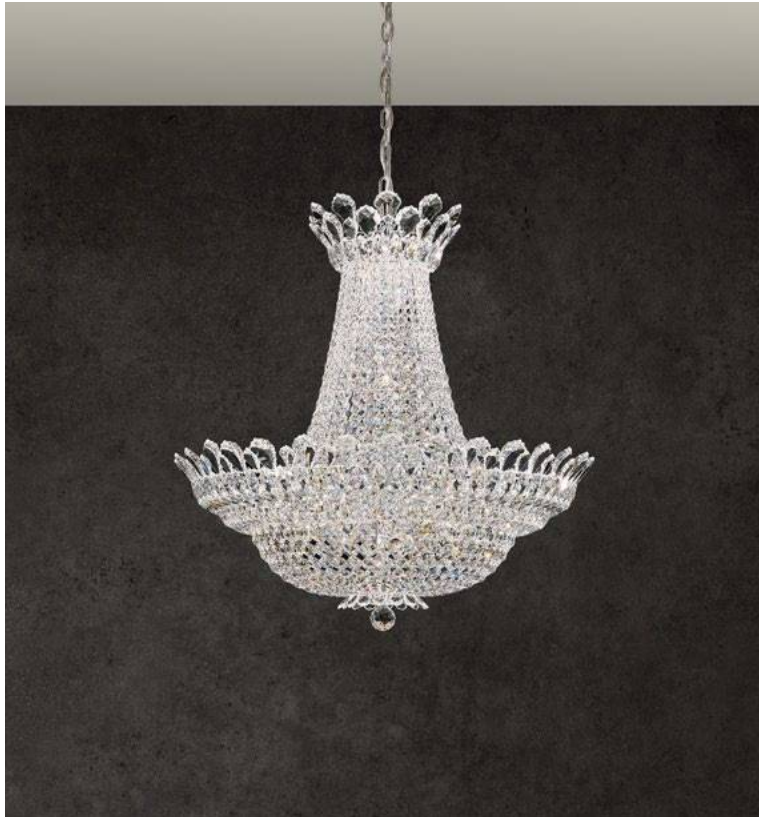









Chandelier		5875	
 (A)	 (-40)		156 lbs / 70.2 kg
			-





	48 in / 122 cm		75-B10 60max
	56 in / 142 cm		1-G161/2 60max
	-		74-B35 40max
	126 in / 320 cm		1-P45 40max
	206 in / 523 cm	AVL	110V, 220V, CCC











Chandelier		5873	
	(A)		(-40)
	66 lbs / 29.7 kg		-

	33 in / 84 cm		52-B10 60max
	35 in / 89 cm		1-G161/2 60max
	-		52-B35 40max
	126 in / 320 cm		1-P45 40max
	213 in / 541 cm	AVL	110V, 220V, CCC



Chandelier		5872	
	(A)		(-40)
	50 lbs / 22.5 kg		-

	28 in / 71 cm		39-B10 60max
	30 in / 76 cm		1-G161/2 60max
	-		39-B35 40max
	126 in / 320 cm		-
	215 in / 546 cm	AVL	110V, 220V, CCC



Chandelier		5871	
	(A)		(-40)
	35 lbs / 15.8 kg		-

	24 in / 61 cm		24-B10 60max
	24 in / 61 cm		-
	-		24-B35 40max
	80 in / 203 cm		-
	158 in / 401 cm	AVL	110V, 220V, CCC



Chandelier		5858	
	(A)		(-40)
	47 lbs / 21.2 kg		-

	24 in / 61 cm		24-B10 60max
	24 in / 61 cm		-
	-		24-B35 40max
	80 in / 203 cm		-
	159 in / 404 cm	AVL	110V, 220V, CCC



Chandelier		5856	
	(A)		(-40)
	64 lbs / 28.8 kg		-

	30 in / 76 cm		10-B10 40max
	27 in / 69 cm		3-B8 40max
	-		25-B35 40max
	126 in / 320 cm		5-P45 40max
	163 in / 414 cm	AVL	110V, 220V, CCC





Chandelier		5851	
	(A)		(-40)
	30 lbs / 13.5 kg		-
	20 in / 51 cm		15-B10 60max
	19 in / 48 cm		-
	-		15-B35 40max
	40 in / 102 cm		-
	126 in / 320 cm	AVL	110V, 220V, CCC



Chandelier		5849	
	(A)		(-40)
	88 lbs / 39.6 kg		-
	33 in / 84 cm		33-B10 40max
	51 in / 130 cm		15-G161/2 40max
	-		48-B35 40max
	126 in / 320 cm		-
	206 in / 523 cm	AVL	110V, 220V, CCC















Chandelier		5848	
	(A)		(-40)
	45 lbs / 20.3 kg		-
	24 in / 61 cm		24-B10 60max
	38 in / 97 cm		-
	-		24-B35 40max
	80 in / 203 cm		-
	156 in / 396 cm	AVL	110V, 220V, CCC







Chandelier		5847	
	(A)		(-40)
	24 lbs / 10.8 kg		-
	19 in / 48 cm		15-B10 60max
	28 in / 71 cm		-
	-		15-B35 40max
	40 in / 102 cm		-
	161 in / 409 cm	AVL	110V, 220V, CCC











Pendant		5855	
	(A)		(-40)
	37 lbs / 16.7 kg		-





	25 in / 64 cm		15-B10 60max
	19 in / 48 cm		-
	-		15-B35 40max
	80 in / 203 cm		-
	163 in / 414 cm	AVL	110V, 220V, CCC











Pendant		5853	
	(A)		(-40)
	14 lbs / 6.3 kg		-

	16 in / 41 cm		6-B10 60max
	13 in / 33 cm		-
	-		4-B35 40max
	40 in / 102 cm		-
	132 in / 335 cm	AVL	110V, 220V, CCC



Pendant		5846	
	(A)		(-40)
	10 lbs / 4.5 kg		-

	12.5 in / 32 cm		5-B10 60max
	17 in / 43 cm		-
	-		5-B35 40max
	40 in / 102 cm		-
	132 in / 335 cm	AVL	110V, 220V, CCC



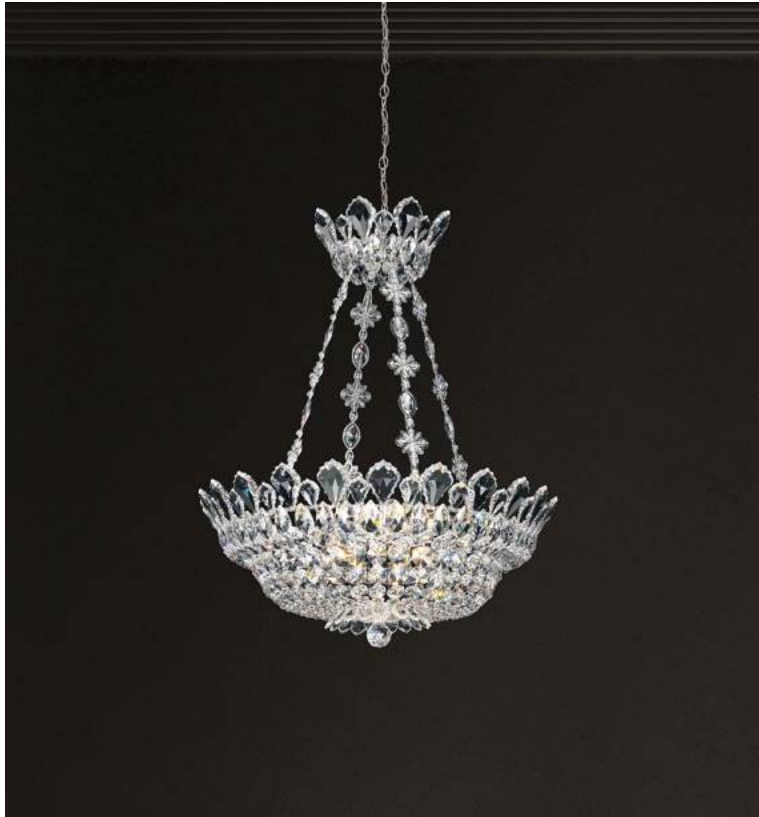

Pendant		5799	
	(A)		(-40)
	22.5 lbs / 10.1 kg		-

	24 in / 61 cm		12-B10 60max
	28 in / 71 cm		-
	-		12-B35 40max
	80 in / 203 cm		-
	145 in / 368 cm	AVL	110V, 220V, CCC



Pendant		5798	
	(A)		(-40)
	15 lbs / 6.8 kg		-

	19 in / 48 cm		8-B10 60max
	23 in / 58 cm		-
	-		8-P45 40max
	40 in / 102 cm		-
	120 in / 305 cm	AVL	110V, 220V, CCC



Close to Ceiling		5877	
	(A)		(-40)
	48 lbs / 21.6 kg		-





	33 in / 84 cm		22-B10 40max
	13.5 in / 34 cm		1-G161/2 40max
	-		23-B35 40max
	-		-
	-	AVL	110V, 220V











Close to Ceiling		5868	
	(A)		(-40)
	19 lbs / 8.6 kg		-





	24 in / 61 cm		8-B10 40max
	10.5 in / 27 cm		2-G161/2 40max
	-		8-B35 40max
	-		-
	-	AVL	110V, 220V











Close to Ceiling		5867	
 (A)	 (-40)		
 13 lbs / 5.9 kg	 -		





 19 in / 48 cm	 110	8-B10 40max
 9 in / 23 cm	 110 ^h	-
 -	 220	8-B35 40max
 -	 220 ^h	-
 -	AVL	110V, 220V











Close to Ceiling		5797	
 (A)	 (-40)		
 20 lbs / 9.0 kg	 -		

 24 in / 61 cm	 110	8-B10 60max
 19 in / 48 cm	 110 ^h	2-G161/2 60max
 -	 220	10-B35 40max
 -	 220 ^h	-
 -	AVL	110V, 220V



Close to Ceiling		5796	
 (A)	 (-40)		
 14 lbs / 6.3 kg	 -		

 19 in / 48 cm	 110	8-B10 60max
 15 in / 38 cm	 110 ^h	-
 -	 220	8-P45 40max
 -	 220 ^h	-
 -	AVL	110V, 220V

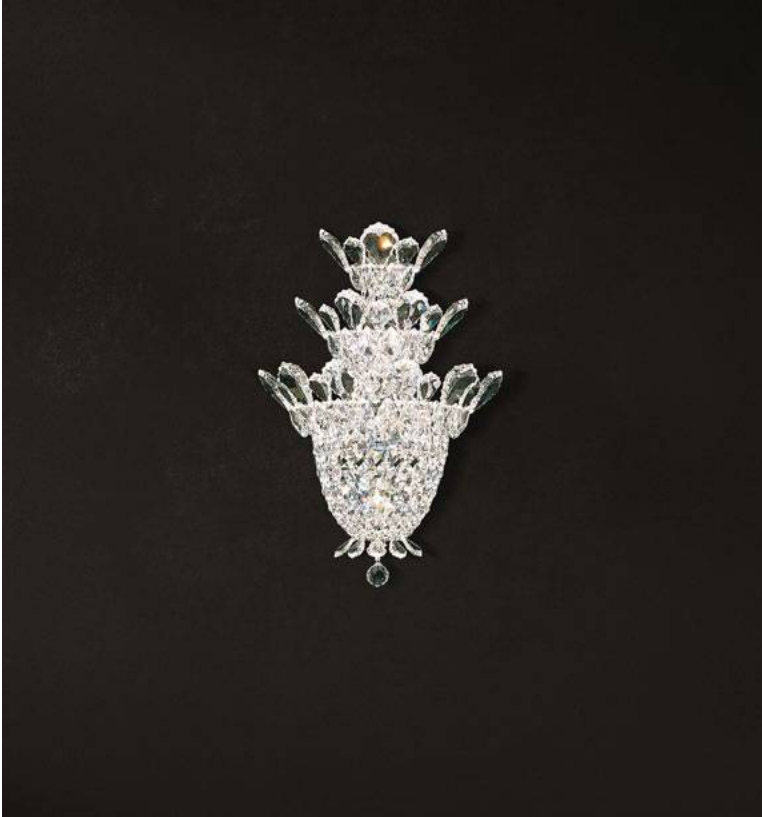

Wall Sconce		5888	
	(A)		(-40)
	10 lbs / 4.5 kg		-

	12.5 in / 32 cm		2-B10 40max
	19 in / 48 cm		2-G161/2 40max
	6.5 in / 17 cm		1-B35 25max
	-		3-P45 25max
	-	AVL	110V, 220V



Wall Sconce		5876	
	(A)		(-40)
	5 lbs / 2.3 kg		-

	11.5 in / 29 cm		3-B10 40max
	10.5 in / 27 cm		-
	6 in / 15 cm		1-B35 25max
	-		2-P45 25max
	-	AVL	110V, 220V

American Romance

2



romantic

Schonbek's American Romantic Collection finds a harmonious balance between its Traditional and Contemporary Collections. Fixtures with feminine curves and masculine lines are elegant and minimalist. They have the graceful silhouette of traditional design without the ornate details, allowing them to complement a variety of interiors from contemporary to transitional to classic. This collection will particularly appeal to those who enjoy an ambience that is airy and open, yet inviting and warm.



Overview



Bella Rose
232 – 235



Jasmine
242 – 247



Esmery
236 – 241



Modique
248 – 253



St. Simons
254 – 257

NEW



Tassau
262 – 269



Talahi
258 – 261

NEW

Bella Rose

A diamond-shaped pattern of crystal beading gives the illusion of a lacy drum shade wreathing a metallic collar frame in the Bella Rose collection. A soft aura of light flows from candle slips supported by curved arms delicately draped with crystal strands, for a look that is both elegant and dramatic.

Canopy Options



110V

* Product only available in 110V

Crystal Options

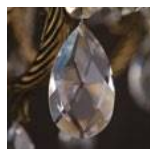

Spectra Crystal
(A)

Finish Options



White
(-06)



Heirloom Gold
(-22)



Etruscan Gold
(-23)















Antique Silver
(-48)















Ferro Black
(-59)

















Pendant		TC1036			36 in / 91 cm		10-B10 40max
					36 in / 91 cm		-
	(A)		(-22)		-		-
	29 lbs / 13.15 kg		-		40 in / 120 cm		-
					100 in / 254 cm	AVL	110V



Pendant		TC1024	
	(A)		(-40)
	18 lbs / 8.1 kg		-
	24 in / 61 cm		6-B10 40max
	21.5 in / 54 cm		-
	-		-
	40 in / 120 cm		-
	114 in / 290 cm	AVL	110V



Pendant		TC1018	
	(A)		(-59)
	14 lbs / 6.35 kg		-
	18 in / 45 cm		5-B10 40max
	20 in / 51 cm		-
	-		-
	40 in / 120 cm		-
	114 in / 290 cm	AVL	110V

Esmery

Esmery captures the mood of the moment with its minimalistic, contemporary style. Beaded crystal chains drape their fiery brilliance creating a play of light and energy around the clean silhouette of the chandelier. Large, sparkling octagon crystals anchor the chains to the chandelier's metal rings in a subtle gesture that adds a touch of everyday magic to an otherwise simple and clean design.

Canopy Options



110V

* Product only available in 110V

Crystal Options



Heritage Crystal (H)



Crystals from Swarovski (S)

Finish Options



White (-06)



Heirloom Gold (-22)



Etruscan Gold (-23)



French Gold (-26)



Polished Silver (-40)



Antique Silver (-48)



Ferro Black (-59)



Heirloom Bronze (-76)

















Aurelia (-211)







Chandelier		AR1012	
 (H)	 (-48)		
	17 lbs / 7.7 kg		-

	37 in / 94 cm		12-B10 60max
	39 in / 99 cm		-
	-		-
	80 in / 203 cm		-
	140 in / 356 cm	AVL	110V



Chandelier		AR1008	
	(H)		(-06)
	13 lbs / 6 kg		-
	37 in / 94 cm		8-B10 60max
	28.5 in / 72.5 cm		-
	-		-
	40 in / 102 cm		-
	140 in / 356 cm	AVL	110V















Chandelier		AR1006	
	(H)		(-22)
	10 lbs / 4.5 kg		-
	28 in / 71 cm		6-B10 60max
	23.5 in / 60 cm		-
	-		-
	40 in / 102 cm		-
	140 in / 356 cm	AVL	110V



Chandelier		AR1004	
	(S)		(-40)
	8 lbs / 3.6 kg		-
	21 in / 53.5 cm		4-B10 60max
	20.5 in / 52 cm		-
	-		-
	40 in / 102 cm		-
	140 in / 356 cm	AVL	110V



Wall Sconce		AR1002	
 (H)		 (-59)	
 2 lbs / 1 kg			-

	12.5 in / 32 cm	 110	2-B10 60max
	16 in / 41 cm	 110	-
	7 in / 18 cm	 220	-
	-	 220	-
	-	AVL	110V

Jasmine

The subtle grace of Jasmine, with its silver and crystal frame and stark lines, and thick single stalactite, is the ideal choice for a chic, contemporary interior.

Canopy Options



110V

* Product only available in 110V

Crystal Options



Optic
(CL)





Finish Options











Polished Silver
(-40)

















Chandelier		9695	
	(CL)		(-40)
	27 lbs / 12.2 kg		-













	42 in / 107 cm		10-B10 60max
	27 in / 69 cm		-
	25 in / 64 cm		-
	120 in / 305 cm		-
	122 in / 310 cm	AVL	110V







Chandelier		9690	
	(CL)		(-40)
	50 lbs / 22.5 kg		-
	36 in / 91 cm		20-B10 60max
	57 in / 145 cm		-
	-		-
	120 in / 305 cm		-
	208 in / 528 cm	AVL	110V









American Romantic







Chandelier		9685	
	(CL)		(-40)
	31 lbs / 14.0 kg		-
	36 in / 91 cm		15-B10 60max
	37.5 in / 95 cm		-
	-		-
	40 in / 102 cm		-
	146 in / 371 cm	AVL	110V











Chandelier		9679	
	(CL)		(-40)
	21 lbs / 9.5 kg		-





	33 in / 84 cm		9-B10 60max
	29.5 in / 75 cm		-
	-		-
	40 in / 102 cm		-
	154 in / 391 cm	AVL	110V











Chandelier		9676	
	(CL)		(-40)
	13 lbs / 5.9 kg		-













	22.5 in / 57 cm		6-B10 60max
	24 in / 61 cm		-
	-		-
	40 in / 102 cm		-
	122 in / 310 cm	AVL	110V















Chandelier		9675	
	(CL)		(-40)
	11 lbs / 5.0 kg		-

	20 in / 51 cm		5-B10 60max
	22 in / 56 cm		-
	-		-
	40 in / 102 cm		-
	124 in / 315 cm	AVL	110V



Wall Sconce		9672	
	(CL)		(-40)
	3 lbs / 1.4 kg		-
	14 in / 36 cm		2-B10 60max
	14 in / 36 cm		-
	5.5 in / 14 cm		-
	-		-
	-	AVL	110V



Wall Sconce		9671	
	(CL)		(-40)
	2 lbs / 0.9 kg		-
	5.5 in / 14 cm		1-B10 60max
	13.5 in / 34 cm		-
	7 in / 18 cm		-
	-		-
	-	AVL	110V

Modique

Skillfully executed modernist design defines the Modique Collection, for lighting that is balanced and beautiful. Simple arms convey elegance and serenity as they move outward in a gentle modern twist, anchored by sleek glass bobeches and minimal crystal ornamentation. In a departure from traditional chandelier design, ornate detailing is absent, allowing function to dictate a form whose focus falls on the simple palette of high-quality materials.

Canopy Options



110V

* Product only available in 110V

Crystal Options



Heritage Crystal (H)



Crystals from Swarovski (S)

Finish Options



White (-06)



Heirloom Gold (-22)



Etruscan Gold (-23)



French Gold (-26)



Polished Silver (-40)



Antique Silver (-48)



Ferro Black (-59)



Heirloom Bronze (-76)















Aurelia (-211)







Chandelier		MD1012	
 (H)	 (-06)		
 17 lbs / 7.7 kg	 -		

	39.5 in / 100 cm		12-B10 60max
	16 in / 40 cm		-
	-		-
	40 in / 102 cm		-
	133 in / 338 cm	AVL	110V



Chandelier		MD1015	
◊ (H)		○ (-48)	
⊙ 25 lbs / 11.3 kg		☀ -	
↔ 39.5 in / 100 cm		💡 110	15-B10 60max
↑↓ 22 in / 56 cm		💡 110	-
↘ -		💡 220	-
↓ 40 in / 102 cm		💡 220	-
🌀 133 in / 338 cm		AVL	110V















Chandelier		MD1006	
◊ (S)		○ (-40)	
⊙ 13 lbs / 5.9 kg		☀ -	
↔ 32 in / 81 cm		💡 110	6-B10 60max
↑↓ 15.5 in / 39 cm		💡 110	-
↘ -		💡 220	-
↓ 40 in / 102 cm		💡 220	-
🌀 133 in / 338 cm		AVL	110V



Chandelier		MD1005	
◊ (H)		○ (-76)	
⊙ 12 lbs / 5.4 kg		☀ -	
↔ 27 in / 68.5 cm		💡 110	5-B10 60max
↑↓ 15.5 in / 39 cm		💡 110	-
↘ -		💡 220	-
↓ 40 in / 102 cm		💡 220	-
🌀 133 in / 338 cm		AVL	110V



Wall Sconce		MD1002	
 (H)		 (-23)	
 3 lbs / 1.3 kg			-

	11 in / 30 cm		2-B10 60max
	11 in / 30 cm		-
	5 in / 13 cm		-
	-		-
	-	AVL	110V

St. Simons

With slender unadorned arms, tall candles and long teardrop crystal pendants, St. Simons chandeliers bring a light feminine touch to the spaces they illuminate. Like a prima ballerina, St. Simons appears delicate, but has impeccable poise and remarkable presence. It is easy to imagine a member of the St. Simons line of chandeliers adding a romantic note to a contemporary living room or contributing to a gracious welcome in the foyer of a classical home.

Crystal Options



Heritage Crystal
(H)

Finish Options



Polished Silver
(-40)



Heirloom Silver
(-44)







American Romantic











Chandelier		CJ1006	
	(H)		(-40)
	17.6 lbs / 8 kg		-

	16.5 in / 42 cm		6-B10 60max
	25 in / 64 cm		-
	-		6-B35 40max
	40 in / 102 cm		-
	122 in / 310cm	AVL	110V, 220V



Chandelier		CJ1004	
	(H)		(-44)
	6.6 lbs / 3 kg		-

	20.1 in / 51 cm		4-B10 60max
	20.1in / 51 cm		-
	-		4-B35 40max
	40 in / 102 cm		-
	122 in / 310 cm	AVL	110V, 220V



Talahi

Named for an enchanting barrier island off the coast of Georgia, Talahi fixtures combine simple elegance with delightful details. The arms of the chandeliers are inspired by the arc of stems in a bouquet of freshly cut flowers with heavy blooms. Talahi's wall sconces and ceiling-mounted fixtures reinterpret the patterns of lace doilies in decorative metalwork. Petite crystals add delicate touches of sparkle that catch the eye.

Crystal Options



Heritage Crystal
(H)

Finish Options



Heritage Heirloom Gold
(-B22)







Heritage Antique Silver
(-B48)













Chandelier		BF1006		↔	25.2 in / 64 cm		6-B10 60max
				↑	25.2in / 64 cm		-
	(H)		(-B48)		-		6-B35 40max
	6.1 lbs / 2.8 kg		-	↓	40 in / 102 cm		-
				∞	122 in / 310 cm	AVL	110V, 220V



Chandelier		BF1004	
	(H)		(-B22)
	4.8 lbs / 2.2 kg		-

	20.1 in / 51 cm		4-B10 60max
	20.1in / 51 cm		-
	-		-
	40 in / 102 cm		-
	122 in / 310 cm	AVL	110V



Tassau

Tassau is an Art Deco-inspired chandelier that brings the glamour of the era into the 21st century with a play on the popular fashion trend of tassel accents. Intricately designed and carefully handcrafted metal tassels are suspended from circular pieces of sparkling crystal rings. Small details like the exquisite crystal banding on the two-tone tassels and a glimmering metallic effect on the underside of the crystal ring epitomizes the luxury of bygone days when ornate handmade tassels accented the furnishings found within opulent interiors.

Canopy Options



110V

* Product only available in 110V

Crystal Options



Spectra Crystal
(A)



Crystals from Swarovski
(S)

Finish Options



Jet Black
(-55)















Polished
Stainless Steel
(-401)







Chandelier		GT1015	
 (S)	 (-55)		
 31 lbs / 14.0 kg	 -		

 41.5 in / 105 cm	 110	15-B10 60max
 30 in / 76 cm	 110	-
 -	 220	-
 40 in / 102 cm	 220	-
 140 in / 356 cm	AVL	110V



Chandelier		GT1025	
	(S)		(-55)
	31 lbs / 14.0 kg		-

	41.5 in / 105 cm		15-B10 60max
	30 in / 76 cm		-
	-		-
	40 in / 102 cm		-
	140 in / 356 cm	AVL	110V



Chandelier		GT1022	
	(A)		(-36)
	28 lbs / 12.6 kg		-

	42.5 in / 108 cm		12-B10 60max
	26 in / 66 cm		-
	-		-
	40 in / 102 cm		-
	140 in / 356 cm	AVL	110V



Chandelier		GT1019	
	(A)		(-401)
	20 lbs / 9.0 kg		-
	31.5 in / 80 cm		9-B10 60max
	25 in / 64 cm		-
	-		-
	40 in / 102 cm		-
	140 in / 356 cm	AVL	110V



Chandelier		GT1017	
	(S)		(-401)
	18 lbs / 8.1 kg		-
	26 in / 66 cm		7-B10 60max
	25 in / 64 cm		-
	-		-
	40 in / 102 cm		-
	140 in / 356 cm	AVL	110V



Chandelier		GT1016	
	(A)		(-401)
	17 lbs / 7.7 kg		-
	25 in / 64 cm		6-B10 60max
	26 in / 66 cm		-
	-		-
	40 in / 102 cm		-
	140 in / 356 cm	AVL	110V





Chandelier		GT1012	
	(A)		(-36)
	28 lbs / 12.6 kg		-
	42.5 in / 108 cm		12-B10 60max
	26 in / 66 cm		-
	-		-
	40 in / 102 cm		-
	140 in / 356 cm	AVL	110V



Chandelier		GT1009	
	(A)		(-401)
	20 lbs / 9.0 kg		-
	31.5 in / 80 cm		9-B10 60max
	25 in / 64 cm		-
	-		-
	40 in / 102 cm		-
	140 in / 356 cm	AVL	110V















Chandelier		GT1007	
	(S)		(-401)
	18 lbs / 8.1 kg		-
	26 in / 66 cm		7-B10 60max
	25 in / 64 cm		-
	-		-
	40 in / 102 cm		-
	140 in / 356 cm	AVL	110V















Chandelier		GT1006	
	(A)		(-401)
	17 lbs / 7.7 kg		-
	25 in / 64 cm		6-B10 60max
	26 in / 66 cm		-
	-		-
	40 in / 102 cm		-
	140 in / 356 cm	AVL	110V



Wall Sconce		GT1011	
	(A)		(-401)
	4 lbs / 1.8 kg		-
	5.5 in / 14 cm		1-B10 60max
	23 in / 58 cm		-
	5.5 in / 14 cm		-
	-		-
	-	AVL	110V



Wall Sconce		GT1002	
	(S)		(-401)
	4 lbs / 1.8 kg		-
	5.5 in / 14 cm		1-B10 60max
	23 in / 58 cm		-
	5.5 in / 14 cm		-
	-		-
	-	AVL	110V

3



American Rust



R
U
C

The heart of Schonbek's American Rustic Collection is its authentic character and down-to-earth spirit. Pieces are distinctive for pairing timeless grace with raw beauty. Elegant shapes rendered in materials offering a rough or aged appearance fit as perfectly with interiors that have been lovingly designed with antique or historical furnishings as they do with modern or farmhouse-inspired homes that incorporate salvaged materials. Rustic fixtures illuminate dinner parties and intimate conversations without pretense – this is what truly makes them shine.

Overview



**Early
American**
274 – 279



Emilea
280 – 285



Fyra
286 – 291



Vesca
292 – 301

Early American

Revisit days gone by with the classic Early American chandelier. Simple metal ribbons flow down to a circlet of sumptuous hand-finished metalwork trimmed with an array of precious crystal. Or choose a basket style chandelier, with festoons of sparkling crystal adding grace to the elegantly curved arms. The Early American collection makes an investment in the spirit of the past and gives an heirloom piece of unparalleled excellence to the future.

Canopy Options



110V*



110V*

* Product only available in 110V

Crystal Options

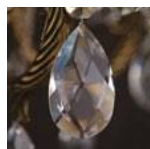

Spectra Crystal
(A)



Crystals from Swarovski
(S)

Finish Options



White
(-06)



Etruscan Gold
(-23)



Heirloom Silver
(-44)



Antique Silver
(-48)







Ferro Black
(-59)











Heirloom Bronze
(-76)





Chandelier		ER1018	
	(S)		(-44)
	17 lbs / 7.71 kg		-

	32.5 in / 82.5 cm		10B10 40max
	31 in / 78.7 cm		-
	-		-
	40 in / 120 cm		-
	228 in / 579 cm	AVL	110V



Chandelier		ER1016	
	(A)		(-76)
	9 lbs / 4 kg		-

	25.5 in / 64.7 cm		6-B10 40max
	21 in / 53.3 cm		-
	-		-
	40 in / 120 cm		-
	228 in / 579 cm	AVL	110V



Chandelier		ER1008	
	(A)		(-44)
	17 lbs / 7.71 kg		-

	31 in / 78.7 cm		8-B10 40max
	21.5 in / 54.6 cm		-
	-		-
	40 in / 120 cm		-
	228 in / 579 cm	AVL	110V



Chandelier		ER1006	
	(A)		(-76)
	9 lbs / 4 kg		-

	25 in / 63.5 cm		6-B10 40max
	19 in / 48.3 cm		-
	-		-
	40 in / 120 cm		-
	228 in / 579 cm	AVL	110V

















Close to Ceiling		ER1211	
	(A)		(-48)
	11 lbs / 5 kg		-
	19.5 in / 49.5 cm		4-B10 40max
	8 in / 20.3 cm		-
	-		-
	-		-
	-	AVL	110V



Close to Ceiling		ER1201	
	(A)		(-76)
	11 lbs / 5 kg		-
	14.5 in / 36.8 cm		4-B10 40max
	13.5 in / 34.3 cm		-
	-		-
	-		-
	-	AVL	110V



Bath Bar		ER2440	
 (A)	 (-23)		
 7 lbs / 3.17 kg	 -		

	21 in / 54 cm		3-B10 40max
	12 in / 30.5 cm		-
	9.5 in / 24.1 cm		-
	-		-
	-	AVL	110V

Emilea

The Emilea chandelier offers a look that combines the best of both worlds. Emilea has a classic, cast arm structure interspersed with crystal accents for a modern and sleek look, and is a subtly elegant design perfect for today's interiors.

Canopy Options



110V*

*For 220V canopy information:
please contact customer service

Crystal Options



Optic Crystal
(0)

Finish Options



White
(-06)



Heirloom Gold
(-22)



Etruscan Gold
(-23)



French Gold
(-26)



Antique Silver
(-48)



Jet Black
(-55)















Heirloom Bronze
(-76)



American Rustic



Chandelier		MA1012	
	(0)		(-26)
	28 lbs / 12.6 kg		-

	32.5 in / 83 cm		12-B10 40max
	30.5 in / 77 cm		-
	-		12-B35 40max
	40 in / 102 cm		-
	124 in / 315 cm	AVL	110V, 220V



Chandelier		MA1008	
	(0)		(-48)
	26 lbs / 11.7 kg		-
	33 in / 84 cm		8-B10 40max
	24 in / 61 cm		-
	-		8-B35 40max
	40 in / 102 cm		-
	123 in / 312 cm	AVL	110V, 220V



Chandelier		MA1006	
	(0)		(-06)
	21 lbs / 9.5 kg		-
	30.5 in / 77 cm		6-B10 40max
	22.5 in / 57 cm		-
	-		6-B35 40max
	40 in / 102 cm		-
	125 in / 318 cm	AVL	110V, 220V



Chandelier		MA1005	
	(0)		(-22)
	14 lbs / 6.3 kg		-
	19.5 in / 50 cm		5-B10 40max
	22.5 in / 57 cm		-
	-		5-B35 40max
	40 in / 102 cm		-
	125 in / 318 cm	AVL	110V, 220V

















Pendant		MA1004	
	(0)		(-55)
	11 lbs / 5 kg		-
	17 in / 43 cm		4-B10 40max
	-		-
	24 in / 61 cm		4-B35 40max
	124 in / 315 cm		-
	144 in / 366 cm	AVL	110V, 220V



Pendant		MA1003	
	(0)		(-06)
	3 lbs / 1.36 kg		-
	6 in / 15 cm		1-B10 40max
	-		-
	16.5 in / 42 cm		1-B35 40max
	135 in / 342 cm		-
	144 in / 366 cm	AVL	110V, 220V



Wall Sconce		MA1002	
	(0)		(-211)
	5 lbs / 2.3 kg		-

	13 in / 33 cm		2-B10 40max
	20 in / 51 cm		-
	8.5 in / 22 cm		2-B35 40max
	-		-
	-	AVL	110V, 220V

Fyra

Fyra enchants the beholder with pieces of perfectly faceted crystal peeking through a windowless lantern-like handmade metal frame. Large chunks of crystal catch and hold light from every angle, then release it into space, shredded into myriad flickering fragments of color. The collection offers single and triple pendants in several sizes as a focal point for any space.

Dimmable By Line Voltage

Crystal Options



Crystals from Swarovski (S)

Finish Options



Black (-BK1)
With Gold
Accent





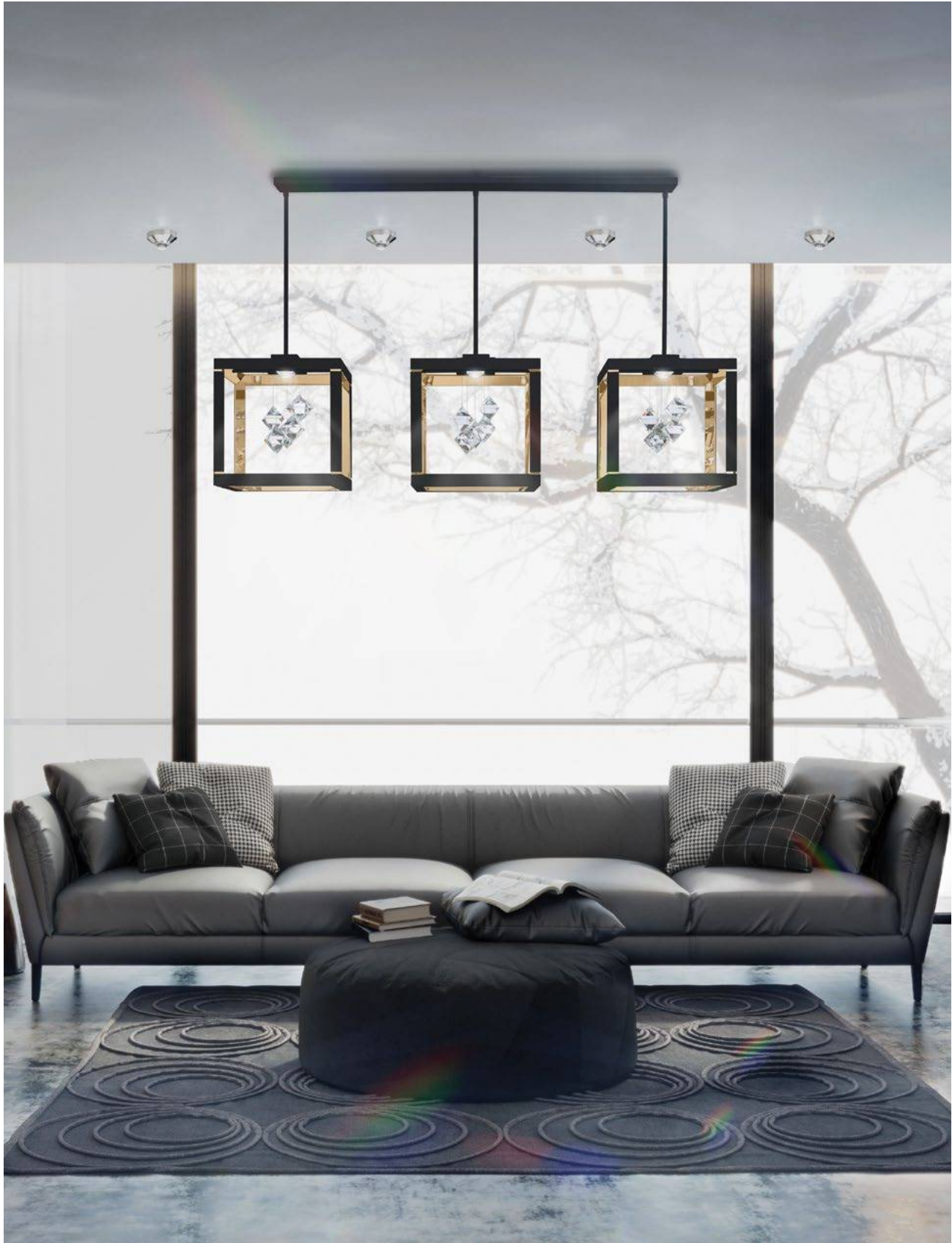

White (-WH1)
With Silver
Accent





























American Rustic











Pendant		SQB710	
	(S)		(-WH1)
	7.5 lbs / 3.5 kg		3000 K

	14 in / 36 cm		3-LED 8max, Incl.
	14 in / 36 cm		12-LED 9max, Incl.
	14 in / 36 cm		3-LED 8max, Incl.
	144 in / 366 cm		12-LED 9max, Incl.
	144 in / 366 cm	AVL	110V, 220V















Pendant		SQB610	
	(S)		(-BK1)
	32 lbs / 14.5 kg		3000 K
	8 in / 20 cm		3-LED 8max, Incl.
	8 in / 20 cm		-
	8 in / 20 cm		3-LED 8max, Incl.
	144 in / 366 cm		-
	144 in / 366 cm	AVL	110V, 220V















Pendant		SQB510	
	(S)		(-WH1)
	19 lbs / 8.5 kg		3000 K
	14 in / 36 cm		1-LED 8max, Incl.
	14 in / 36 cm		4-LED 9max, Incl.
	14 in / 36 cm		1-LED 8max, Incl.
	144 in / 366 cm		4-LED 9max, Incl.
	144 in / 366 cm	AVL	110V, 220V



Pendant		SQB410	
	(S)		(-BK1)
	10 lbs / 4.5 kg		3000 K
	8 in / 20 cm		1-LED 8max, Incl.
	8 in / 20 cm		-
	8 in / 20 cm		1-LED 8max, Incl.
	144 in / 366 cm		-
	144 in / 366 cm	AVL	110V, 220V



Wall Sconce		SQB110	
 (S)		 (-BK1)	
 11 lbs / 5 kg		 3000 K	

 9 in / 23 cm	 110	1-LED 8max, Incl.
 8 in / 20 cm	 110	-
 8.7 in / 22 cm	 220	1-LED 8max, Incl.
 -	 220	-
 -	AVL	110V, 220V

Vesca

This delicate, graceful chandelier blossoms like a strawberry at spring, evoking the petals of a flower adorned with decorative crystal chains. This unusual design will bring a lyrical atmosphere to charming dining spaces.

Canopy Options



110V



110V*

* Product only available in 110V

Crystal Options



Spectra Crystal
(A)



Heritage Crystal
(H)



Crystals from Swarovski
(S)

Finish Options



White
(-06)



Heirloom Gold
(-22)



Etruscan Gold
(-23)



French Gold
(-26)



Antique Silver
(-48)



Ferro Black
(-59)

















Heirloom Bronze
(-76)







Chandelier		VA8339	
 (A)	 (-22)		
 35 lbs / 15.8 kg	 -		

 45 in / 114 cm	 9-B10 60max
 38 in / 97 cm	 -
 -	 -
 40 in / 102 cm	 -
 137 in / 348 cm	 AVL 110V



Chandelier		VA8355	
	(H)		(-48)
	13 lbs / 5.9 kg		-
	23 in / 58 cm		5-B10 60max
	20 in / 51 cm		-
	-		-
	40 in / 102 cm		-
	137 in / 348 cm	AVL	110V



Chandelier		VA8336	
	(A)		(-06)
	22 lbs / 9.9 kg		-
	33 in / 84 cm		6-B10 60max
	29 in / 74 cm		-
	-		-
	40 in / 102 cm		-
	137 in / 348 cm	AVL	110V



Chandelier		VA8335	
	(A)		(-48)
	17 lbs / 7.7 kg		-

	29 in / 74 cm		5-B10 60max
	27 in / 69 cm		-
	-		-
	40 in / 102 cm		-
	137 in / 348 cm	AVL	110V



Chandelier		VA8322	
	(A)		(-48)
	38 lbs / 17.1 kg		-

	45 in / 114 cm		12-B10 60max
	40 in / 102 cm		-
	-		-
	40 in / 102 cm		-
	134 in / 340 cm	AVL	110V



Chandelier		VA8306	
	(S)		(-76)
	20 lbs / 9.0 kg		-

	28 in / 71 cm		6-B10 60max
	24 in / 61 cm		-
	-		-
	40 in / 102 cm		-
	137 in / 348 cm	AVL	110V





Chandelier		VA8305	
	(S)		(-59)
	17 lbs / 7.7 kg		-













	24 in / 61 cm		5-B10 60max
	20 in / 51 cm		-
	-		-
	40 in / 102 cm		-
	137 in / 348 cm	AVL	110V















Chandelier		VA8304	
	(A)		(-76)
	10 lbs / 4.53 kg		-

	16 in / 40 cm		5-B10 60max
	-		-
	-		-
	40 in / 102 cm		-
	133 in / 338 cm	AVL	110V



Pendant		VA8436	
	(S)		(-48)
	35 lbs / 15.87 kg		-
	58 in / 147 cm		8-B10 60max
	30 in / 76 cm		-
	27 in / 68 cm		-
	40 in / 102 cm		-
	133 in / 338 cm	AVL	110V







Pendant		VA8435	
	(A)		(-23)
	30 lbs / 13.6 kg		-
	46 in / 116 kg		8-B10 60max
	24 in / 61 cm		-
	20.5 in / 52 cm		-
	40 in / 102 cm		-
	133 in / 338 cm	AVL	110V











Close to Ceiling		VA8312	
◊	(H)	○	(-76)
⊕	14 lbs / 6.3 kg	☀	-

↔	29 in / 74 cm	💡 110	5-B10 60max
↑↓	23 in / 56 cm	💡 110	-
↘↙	-	💡 220	-
↓	-	💡 220	-
100	-	AVL	110V



Wall Sconce		VA8332	
	(S)		(-23)
	4 lbs / 1.8 kg		-

	13 in / 33 cm		2-B10 60max
	16 in / 41 cm		-
	9 in / 23 cm		-
	-		-
	-	AVL	110V





America



Schonbek's American Contemporary Collection is founded in styles developed during the latter half of the 20th century, takes further inspiration from current trends in culture, art, and society, and sets itself apart by instilling a sense of natural warmth in every piece. The result is an array of fixtures that make bold spatial statements while staying mindful of what will remain timeless. They are ideal for people who are attracted by the sophistication that comes from simple lines, forms, and shapes in perfect balance.

4

on Contemporary

Overview



Alon
306 – 309



Cassini
324 – 329



Crystal Empire
354 – 357



Amaca
310 – 313



Chantant
330 – 343



Esteracae
358 – 363



Asheville
314 – 317

NEW



Chatter
344 – 347



Glissando
364 – 369



Baronet
318 – 323



Circulus
348 – 353



Infinite Aura
370 – 377



Madison
378 – 379



Riviera
394 – 399



Vega
420 – 423



Octa
380 – 381



Selene
400 – 405



Verve
424 – 427



Quantum
382 – 389



SoHo
406 – 411

NEW



Refrax
390 – 393



Trilliane Strands
412 – 419

Alon

Inspired by the graceful frolic of sunlight sparkling on gentle ocean waves, Alon's crystal strands invite exploration of notions of balance, harmony, and playfulness. Sparkles appear to ebb and flow in a scintillating play of light like rays of sun glimmering across the sea, as downlights embedded within the canopy illuminate the strands from above.

Dimmable By Phase Cut

* Product only available in 110V

Crystal Options



Crystals from Swarovski (S)













Finish Options







Stainless Steel (-SS1)













Pendant		SRI500			60 in / 152 cm		6-LED 8max, Incl.
	(S)		(-SS1)		18 in / 46 cm		-
	37 lbs / 16.8 kg		-		19 in / 48 cm		-
					144 in / 366 cm		-
					144 in / 366 cm	AVL	110V



Pendant		SRI400	
	(S)		(-SS1)
	19 lbs / 8.6 kg		-

	40.5 in / 103 cm		4-LED 8max, Incl.
	12.5 in / 32 cm		-
	14 in / 36 cm		-
	144 in / 366 cm		-
	144 in / 366 cm	AVL	110V



Amaca

Brilliant crest shapes grace any minimalist room with their feather-light presence. A straightforward trio of cables affix to a sleek crossbar and layer industrial ease with the intrigue of a net sprinkled with up to 400 Swarovski crystals. This style amplifies the energy of a room with a deliberately simple design that accentuates any home's exquisite qualities.

Dimmable By Phase Cut

Crystal Options



Crystals from Swarovski
(S)













Finish Options







Stainless Steel
(-SS1)











Pendant		SHK300		 52 in / 132 cm	 110	2-LED 17max, Incl.
				 7.5 in / 19 cm	 110	-
	(S)		(-SS1)	 7.5 in / 19 cm	 220	2-LED 17max, Incl.
	8 lbs / 3.6 kg		3000 K	 152 in / 386 cm	 220	-
				 152 in / 386 cm	AVL	110V, 220V, CCC



Pendant		SHK200	
	(S)		(-SS1)
	6 lbs / 2.7 kg		3000 K

	30 in / 76 cm		2-LED 8max, Incl.
	6.5 in / 17 cm		-
	6.5 in / 17 cm		2-LED 8max, Incl.
	151 in / 384 cm		-
	151 in / 384 cm	AVL	110V, 220V, CCC



Asheville

Asheville is inspired by the simple geometries and organic forms that have maintained eternal appeal from pre-history to present-day. Large and small pendants are unabashedly contemporary yet would make a brilliant counterpoint within a traditional interior. Open metal circles set on a rod are movable around a cluster of seeded glass globes and the shape of the fixtures appears different from various perspectives.

Crystal Options



Heritage Crystal
(H)





Finish Options











Champange Gold
(-B44)

















Pendant		CW1008	
	(H)		(-B44)
	19.8lbs / 8,9 kg		-

	24 in / 60.9 cm		6-B10 40max
	25 in / 63.5 cm		-
	-		6-B10 40max
	42in / 106.8 cm - Rod		-
	122 in / 310cm	AVL	110V, 220V



Pendant		CW1006	
	(H)		(-B44)
	10.5 lbs / 4.8 kg		-

	18 in / 45.7 cm		6-B10 40max
	19 in / 48.3 cm		-
	-		6-B10 40max
	42in / 106.8 cm – Rod		-
	122 in / 310cm	AVL	110V, 220V



Baronet

Inspired by the great houses of England's nobility, the Baronet collection's dense clusters of crystals bedazzle its streamlined shapes. Like jewels suspended in mid-air, these designs can be paired for dramatic architectural effects or used alone as a vibrant, extravagant highlight in a space.

Canopy Options



110V*

*For 220V canopy information:
please contact customer service

Crystal Options



Spectra Crystal
(A)



Crystals from Swarovski
(S)





Finish Options











Polished
Stainless Steel
(-401)

















Pendant		BN1033	
	(A)		(-401)
	60 lbs / 27.2 kg		-





	33 in / 84 cm		28-B10 60max
	27 in / 69 cm		-
	-		28-B35 40max
	42 in / 107cm		-
	162 in / 411cm	AVL	110V, 220V, CCC











Pendant		BN1024	
	(A)		(-401)
	33 lbs / 14.9 kg		-

	24 in / 61 cm		12-G16-1/2 60max
	20 in / 51 cm		-
	-		12-B35 40max
	40 in / 102 cm		-
	130 in / 330 cm	AVL	110V, 220V, CCC















Pendant		BN1016	
	(A)		(-401)
	22 lbs / 9.9 kg		-













	19 in / 48 cm		8-G16-1/2 60max
	15 in / 38 cm		-
	-		8-P45 40max
	40 in / 102cm		-
	133 in / 338 cm	AVL	110V, 220V, CCC











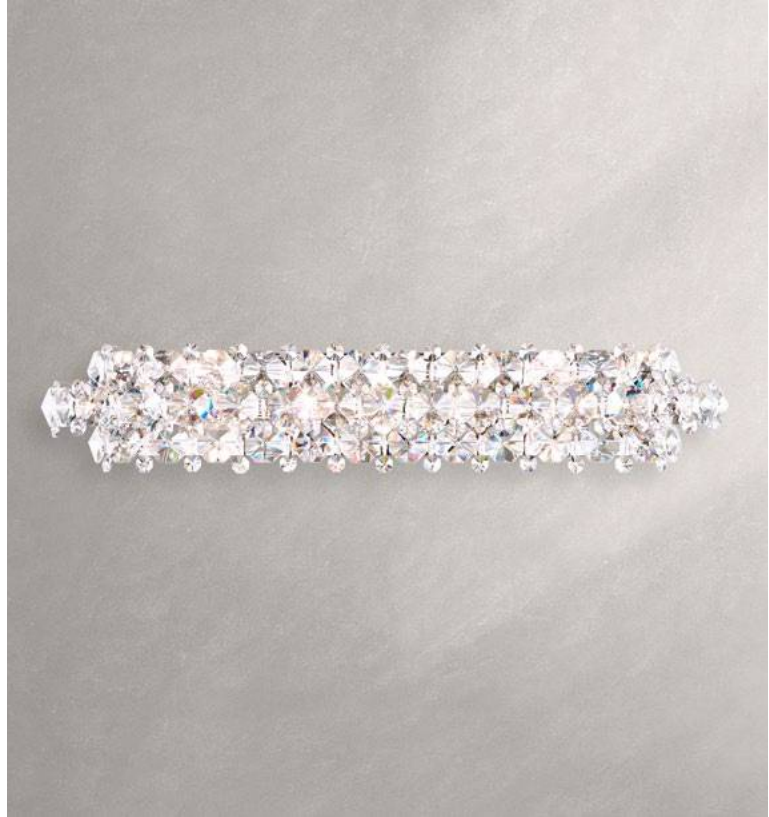







Close to Ceiling		BN1424	
	(A)		(-401)
	32 lbs / 14.5 kg		-
	24 in / 61 cm		6-B10 60max
	12 in / 30 cm		-
	-		6-B35 40max
	-		-
	-	AVL	110V, 220V, CCC









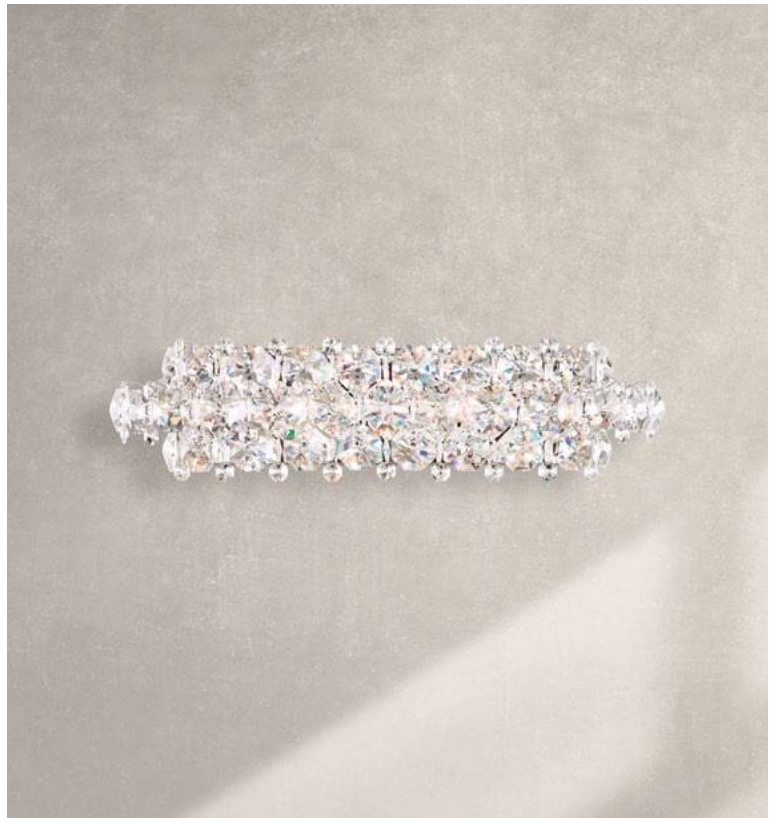





Close to Ceiling		BN1416	
	(A)		(-401)
	20 lbs / 9 kg		-
	19 in / 48 cm		4-B10 60max
	11 in / 28 cm		-
	-		4-B35 40max
	-		-
	-	AVL	110V, 220V, CCC



Bath Bar		BN1236	
	(A)		(-401)
	18 lbs / 8.1 kg		-
	35 in / 89 cm		7-G16-1/2 60max
	6.5 in / 17 cm		-
	6.5 in / 17 cm		7-P45 40max
	-		-
	-	AVL	110V, 220V, CCC



Bath Bar		BN1224	
	(A)		(-401)
	11 lbs / 5 kg		-
	25 in / 64 cm		5-G16-1/2 60max
	6.5 in / 17 cm		-
	6.5 in / 17 cm		5-P45 40max
	-		-
	-	AVL	110V, 220V, CCC

Cassini

Both pure in shape and lavish, this dense crystal ring seems to float in mid-air, glittering like a halo. Inspired by the discovery of the Cassini Division in the rings of Saturn by Renaissance astronomer Giovanni Domenico Cassini in 1675, it is a celebration of the power of the solar system and the astral movements around the sun and moon. This is the extravagant design piece that will add oomph to your dining room and shine a light on your lounge or retail space.

Crystal Options

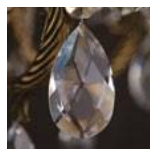

Spectra Crystal
(A)



Crystals from Swarovski
(S)

Finish Options

















Polished
Stainless Steel
(-401)



















Pendant		CA3939	
 (A)	 (-401)		
 62 lbs / 27.9 kg	 -		





 39 in / 99 cm	 28-G9 40max, Incl.
 5.5 in / 14 cm	 -
 -	 28-G9 40max
 144 in / 366 cm	 -
 144 in / 366 cm	 AVL 110V, 220V











Pendant		CA3724	
	(S)		(-401)
	42 lbs / 18.9 kg		-

	37 in / 94 cm		20-G9 40max, Incl.
	4.5 in / 11 cm		-
	24 in / 61 cm		20-G9 40max
	144 in / 366 cm		-
	144 in / 366 cm	AVL	110V, 220V



Close to Ceiling		CA2525	
	(A)		(-401)
	28 lbs / 12.6 kg		-

	25 in / 64 cm		15-G9 40max, Incl.
	13 in / 33 cm		-
	-		15-G9 40max
	144 in / 366 cm		-
	144 in / 366 cm	AVL	110V, 220V



Chantant

A dazzling symphony of crystal strands falling from a circular frame, as if punctuating the notes of a Romantic opus. Choose from a selection of more dramatic designs for a more majestic space or minimalist, compact versions for a discreet, yet splendid, statement.

Canopy Options



110V

* Product only available in 110V

Crystal Options



Heritage Crystal
(H)



Spectra Crystal
(A)

Finish Options















Polished
Stainless Steel
(-401)



















Pendant		CH2413	
	(H)		(-401)
	56 lbs / 25.2 kg		-





	24 in / 61 cm		6-GU10 50max, Incl.
	79 in / 201 cm		-
	-		-
	144 in / 366 cm		-
	144 in / 366 cm	AVL	110V











Pendant		CH4813	
	(H)		(-401)
	63 lbs / 28.4 kg		-













	43 in / 109 cm		8-GU10 50max, Incl.
	52 in / 132 cm		-
	22 in / 56 cm		-
	144 in / 366 cm		-
	144 in / 366 cm	AVL	110V















Pendant		CH4812	
	(H)		(-401)
	51 lbs / 23.0 kg		-

	43 in / 109 cm		8-GU10 50max, Incl.
	27 in / 69 cm		-
	22 in / 56 cm		-
	144 in / 366 cm		-
	144 in / 366 cm	AVL	110V















Pendant		CH4811	
	(H)		(-401)
	43 lbs / 19.4 kg		-
	43 in / 109 cm		8-GU10 50max, Incl.
	18.5 in / 47 cm		-
	22 in / 56 cm		-
	144 in / 366 cm		-
	144 in / 366 cm	AVL	110V















Pendant		CH3612	
	(H)		(-401)
	32 lbs / 14.4 kg		-
	33 in / 84 cm		6-GU10 50max, Incl.
	24 in / 61 cm		-
	15 in / 38 cm		-
	144 in / 366 cm		-
	144 in / 366 cm	AVL	110V



Pendant		CH3611	
	(H)		(-401)
	13 lbs / 5.9 kg		-
	33 in / 84 cm		6-GU10 50max, Incl.
	16.5 in / 42 cm		-
	15 in / 38 cm		-
	144 in / 366 cm		-
	144 in / 366 cm	AVL	110V



Pendant		CH2412	
	(H)		(-401)
	34 lbs / 15.3 kg		-
	24 in / 61 cm		6-GU10 50max, Incl.
	28 in / 71 cm		-
	-		-
	144 in / 366 cm		-
	144 in / 366 cm	AVL	110V

















Pendant		CH1813	
	(A)		(-401)
	45.5 lbs / 20.5 kg		-
	21 in / 53 cm		5-GU10 50max, Incl.
	70.25 in / 178 cm		-
	-		-
	144 in / 366 cm		-
	144 in / 366 cm	AVL	110V







Pendant		CH1812	
	(A)		(-401)
	37 lbs / 16.7 kg		-
	21 in / 53 cm		5-GU10 50max, Incl.
	41.5 in / 105 cm		-
	-		-
	144 in / 366 cm		-
	144 in / 366 cm	AVL	110V









Pendant		CH1212	
	(H)		(-401)
	16 lbs / 7.2 kg		-





	14 in / 36 cm		4-GU10 50max, Incl.
	35 in / 89 cm		-
	-		-
	144 in / 366 cm		-
	144 in / 366 cm	AVL	110V









Pendant		CH1211	
	(H)		(-401)
	14.5 lbs / 6.5 kg		-

	14 in / 36 cm		4-GU10 50max, Incl.
	23 in / 58 cm		-
	-		-
	144 in / 366 cm		-
	144 in / 366 cm	AVL	110V















Pendant		CH0812	
	(H)		(-401)
	10 lbs / 4.5 kg		-













	10.5 in / 27 cm		3-GU10 50max, Incl.
	24.5 in / 62 cm		-
	-		-
	144 in / 366 cm		-
	144 in / 366 cm	AVL	110V

















Close to Ceiling		CH4803	
	(H)		(-401)
	61 lbs / 27.5 kg		-
	43 in / 109 cm		8-GU10 35max, Incl.
	52.5 in / 133 cm		-
	22 in / 56 cm		-
	-		-
	-	AVL	110V















Close to Ceiling		CH4802	
	(H)		(-401)
	49 lbs / 22.1 kg		-
	43 in / 109 cm		8-GU10 35max, Incl.
	27.5 in / 70 cm		-
	22 in / 56 cm		-
	-		-
	-	AVL	110V















Close to Ceiling		CH2403	
	(H)		(-401)
	54 lbs / 24.3 kg		-
	24 in / 61 cm		6-GU10 35max, Incl.
	79.5 in / 202 cm		-
	-		-
	-		-
	-	AVL	110V















Close to Ceiling		CH2402	
	(H)		(-401)
	32 lbs / 14.4 kg		-
	24 in / 61 cm		6-GU10 35max, Incl.
	28.5 in / 72 cm		-
	-		-
	-		-
	-	AVL	110V















Close to Ceiling		CH2401	
	(H)		(-401)
	14 lbs / 6.3 kg		-
	24 in / 61 cm		6-GU10 35max, Incl.
	20.5 in / 52 cm		-
	-		-
	-		-
	-	AVL	110V















Close to Ceiling		CH1801	
	(H)		(-401)
	26 lbs / 11.7 kg		-
	21 in / 53 cm		5-GU10 35max, Incl.
	17 in / 43 cm		-
	-		-
	-		-
	-	AVL	110V







Close to Ceiling		CH1202	
	(H)		(-401)
	14 lbs / 6.3 kg		-
	14 in / 36 cm		4-GU10 35max, Incl.
	35.5 in / 90 cm		-
	-		-
	-		-
	-	AVL	110V











Close to Ceiling		CH1201	
	(H)		(-401)
	12.5 lbs / 5.6 kg		-













	14 in / 36 cm		4-GU10 35max, Incl.
	23.5 in / 60 cm		-
	-		-
	-		-
	-	AVL	110V















Close to Ceiling		CH0802	
	(H)		(-401)
	9.5 lbs / 4.3 kg		-

	10.5 in / 27 cm		3-GU10 35max, Incl.
	25 in / 64 cm		-
	-		-
	-		-
	-	AVL	110V















Wall Sconce		CH3640	
	(A)		(-401)
	17 lbs / 7.7 kg		-
	36 in / 91 cm		6-GU10 40max, Incl.
	9 in / 23 cm		-
	7 in / 18 cm		-
	-		-
	-	AVL	110V







Wall Sconce		CH2440	
	(A)		(-401)
	11 lbs / 5.0 kg		-
	24.5 in / 62 cm		4-G9 40max, Incl.
	8.5 in / 22 cm		-
	7 in / 18 cm		-
	-		-
	-	AVL	110V











Wall Sconce		CH1232	
	(A)		(-401)
	12 lbs / 5.4 kg		-





	14 in / 36 cm		4-G9 40max, Incl.
	18 in / 46 cm		-
	9.5 in / 24 cm		-
	-		-
	-	AVL	110V











Wall Sconce		CH0832	
	(A)		(-401)
	5 lbs / 2.3 kg		-

	6.5 in / 17 cm		2-G9 40max, Incl.
	16 in / 41 cm		-
	6 in / 15 cm		-
	-		-
	-	AVL	110V



Wall Sconce		CH0833	
	(A)		(-401)
	6 lbs / 2.7 kg		-

	6.5 in / 17 cm		2-G9 40max, Incl.
	23 in / 58 cm		-
	6 in / 15 cm		-
	-		-
	-	AVL	110V



Chatter

A glimmering avalanche of hand-finished mixed metal pieces and multi-faceted crystals is cradled by a net of draped crystal strands in the Chatter family, inviting the exploration of notions of balance, harmony, and playfulness. Light radiates through the sophisticated mix of material adding a stunning, shimmering ambiance to any room.

Canopy Options



110V*



110V*

*For 220V canopy information:
please contact customer service

Crystal Options



Spectra Crystal
(A)



Crystals from Swarovski
(S)

Finish Options











Gold Mirror
(-301)















Polished
Stainless Steel
(-401)

















Pendant		MX8346		↔	32.5 in / 83 cm	 110	7-G16-1/2 40max
				↑	8.5 in / 22 cm	 110	-
				↘	14 in / 36 cm	 220	7-P45 40max
				↓	144 in / 366 cm	 220	-
				∞	138 in / 351 cm	AVL	110V, 220V, CCC
	(A)		(-401)				
	18 lbs / 8.1 kg		-				















Pendant		MX8349	
	(S)		(-401)
	40 lbs / 18.1 kg		-
	36 in / 91 cm		18-G16-1/2 40max
	8.5 in / 22 cm		-
	-		18-P45 40max
	144 in / 366 cm		-
	140 in / 356 cm	AVL	110V, 220V, CCC



Pendant		MX8343	
	(A)		(-301)
	26 lbs / 11.7 kg		-
	24 in / 61 cm		12-G16-1/2 40max
	8.5 in / 22 cm		-
	-		12-P45 40max
	144 in / 366 cm		-
	140 in / 356 cm	AVL	110V, 220V, CCC



Pendant		MX8340	
	(S)		(-301)
	29 lbs / 13.1 kg		-
	36 in / 91 cm		12-G16-1/2 40max
	10 in / 25 cm		-
	12 in / 30 cm		12-P45 40max
	144 in / 366 cm		-
	139 in / 353 cm	AVL	110V, 220V, CCC



Circulus

Sophistication and luxury defined the Art Deco design movement, and the Circulus epitomizes this era with its vintage cosmopolitan feel. A cascade of radiant light sparkles from crystal rings and octagons captured within an array of metallic circles that are suspended from a shining lustrous crown. The Circulus collection embraces a revolution of design and style for the modern age.

Canopy Options



110V

* Product only available in 110V

Crystal Options

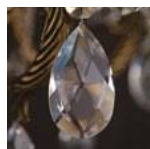

Spectra Crystal
(A)

Finish Options



Heirloom Bronze
(-22)



Antique Silver
(-48)







Aurelia
(-211)

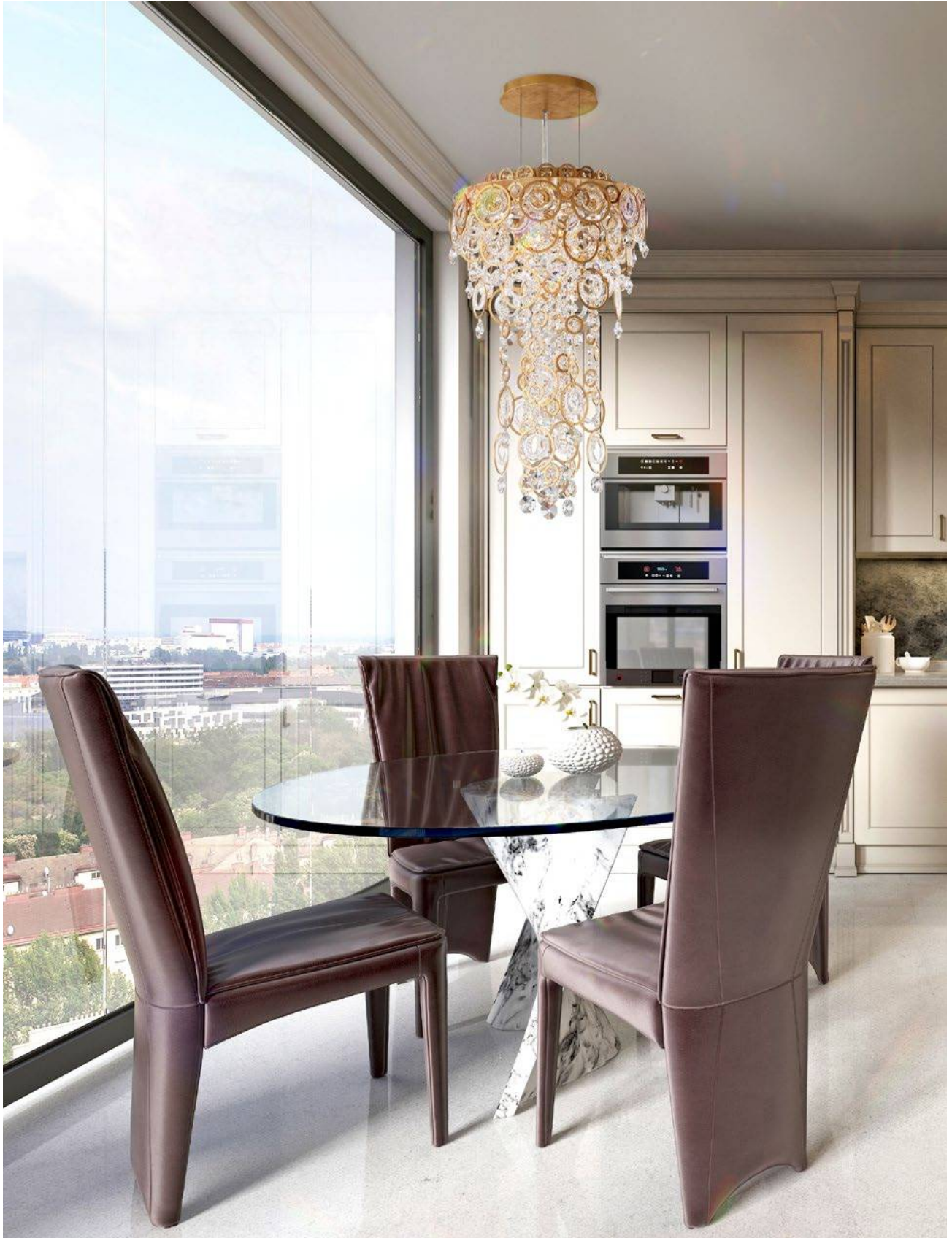









Polished
Stainless Steel
(-401)

















Pendant		DR2412	
	(A)		(-401)
	44 lbs / 19.9 kg		-

	24 in / 61 cm		6-GU10 50max, Incl.
	-		-
	44 in / 112 cm		-
	144 in / 364 cm		-
	144 in / 364 cm	AVL	110V















Pendant		DR1412	
	(A)		(-22)
	22 lbs / 9.9 kg		-

	14 in / 36 cm		4-GU10 50max, Incl.
	-		-
	24 in / 61 cm		-
	144 in / 364 cm		-
	144 in / 364 cm	AVL	110V

















Close to Ceiling		DR1401	
	(A)		(-48)
	18 lbs / 8.1 kg		-

	14 in / 36 cm		4-G9 40max, Incl.
	-		-
	14 in / 36 cm		4-G9 40max, Incl.
	-		-
	-	AVL	110V



Bath Bar		DR2440	
	(A)		(-44)
	13 lbs / 5.89 kg		-

	24 in / 61 cm		4-GU10 35max, Incl.
	7 in / 18 cm		-
	16 in / 40 cm		4-GU10 35max, Incl.
	-		-
	-	AVL	110V



Crystal Empire

Neoclassical in nature, this draped, leather chandelier's structure softens the room. Its smooth sheen is punctuated by an iconic Swarovski crystal ring. Its symmetry and proportionality call to those with a modern take and a penchant for history. Often discovered in spiral stairways or over formal dining tables.

Dimmable By 0-10V

Crystal Options



Crystals from Swarovski (S)

Leather Options



Grizzly Black (-LB1)



Chinook (-LC1)



Iceberg (-LI1)



Red Fox (LR1)

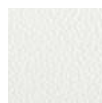

Snowshoe (LS1)















White Pass (-LW1)

















Pendant		SCE130		↔	33.5 in / 85 cm	💡 110	20-LED 3max, Incl.
				↑	44.5 in / 113 cm	💡 110	-
🔹	(S)	○	(-LW1)	↘	-	💡 220	20-LED 3max, Incl.
⦿	40 lbs / 18.1 kg	☀️	3000 K	↓	144 in / 366 cm	💡 220	-
				∞	144 in / 366 cm	AVL	110V, 220V, CCC



Pendant		SCE120	
	(S)		(-LC1)
	28 lbs / 12.7 kg		3000 K
	27 in / 69 cm		16-LED 3max, Incl.
	36 in / 91 cm		-
	-		16-LED 3max, Incl.
	144 in / 366 cm		-
	144 in / 366 cm	AVL	110V, 220V, CCC



Pendant		SCE110	
	(S)		(-LB1)
	20 lbs / 9 kg		3000 K
	20.5 in / 52 cm		12-LED 3max, Incl.
	27 in / 69 cm		-
	-		12-LED 3max, Incl.
	144 in / 366 cm		-
	144 in / 366 cm	AVL	110V, 220V, CCC

Esteracae

Just as the gossamer ball of a dandelion sends a thousand wishes as its seeds are gently blown away, the rounded shape of Esteracae blossoms with a multitude of sparkling polished crystals. Each stem emerging from the center of the orb is topped with a hand-finished metal floret pinned with faceted crystal that shimmers beautifully in the reflected light.

Canopy Options



110V

* Product only available in 110V

Crystal Options



Spectra Crystal
(A)



Crystals from Swarovski
(S)

Finish Options



Heirloom Bronze
(-22)



Antique Silver
(-48)



Jet Black
(-55)



White Lustre
(-306)







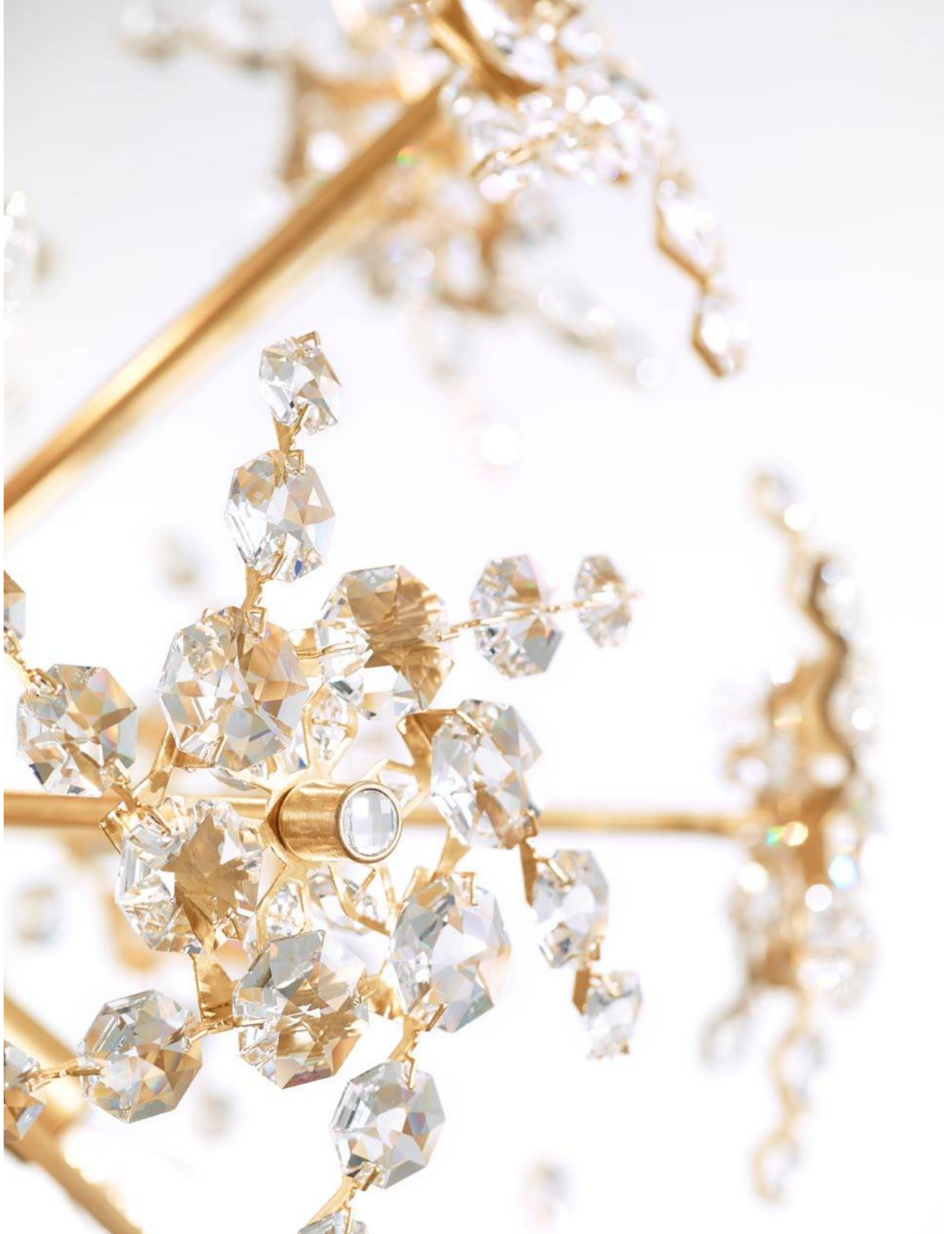







Polished
Stainless Steel
(-401)

































Pendant		DN1036	
	(A)		(-306)
	28 lbs / 12.7 kg		-

	36 in / 92 cm		8-B10 40max
	36 in / 92 cm		-
	-		-
	51 in / 129 cm		-
	120 in / 305 cm	AVL	110V















Pendant		DN1024	
	(A)		(-401)
	18 lbs / 8.1 kg		-
	24 in / 61 cm		6-B10 40max
	24 in / 61 cm		-
	-		-
	51 in / 129 cm		-
	125 in / 318 cm	AVL	110V















Pendant		DN1018	
	(A)		(-22)
	10 lbs / 4.5 kg		-
	18 in / 45 cm		6-B10 40max
	18 in / 45 cm		-
	-		-
	51 in / 129 cm		-
	130 in / 330 cm	AVL	110V



Surface Mount		DN1224	
	(A)		(-401)
	12 lbs / 5.5 kg		-
	24 in / 61 cm		3-B10 40max
	16 in / 41 cm		-
	-		-
	-		-
	-	AVL	110V



Surface Mount		DN1218	
	(A)		(-22)
	10 lbs / 4.55 kg		-
	18 in / 45 cm		3-B10 40max
	11 in / 28 cm		-
	-		-
	-		-
	-	AVL	110V

Glissando

Glissando

Named for glissando, an Italian term describing musical notes gliding upward and downward in perfect harmony, the crystal prisms in the Glissando collection glide from one to another creating a multi-layered stack of sparkling light. Interlocking planes and angles radiate bands of color as the crystal holds and reflects light from its twisted silhouette.

Dimmable by Line Voltage. Not included: STW120 (Phase Cut)

Crystal Options



Crystals from Swarovski
(S)













Finish Options















Stainless Steel
(-SS1)

















Pendant		STW510			9 in / 22.9 cm		1-LED 12max, Incl.
					10 in / 25.4 cm		-
	(S)		(SS1)		9 in / 22.9 cm		1-LED 12max, Incl.
	11 lbs / 5 kg		3000 K		144 in / 366 cm		-
					140 in / 356 cm	AVL	110V, 220V















Pendant		STW410	
	(S)		(SS1)
	6 lbs / 2.7 kg		3000 K
	4.8 in / 12 cm		1-LED 6max, Incl.
	10 in / 25.4 cm		–
	4.8 in / 12 cm		1-LED 6max, Incl.
	144 in / 366 cm		–
	140 in / 356 cm	AVL	110V, 220V















Pendant		STW310	
	(S)		(SS1)
	4 lbs / 2 kg		3000 K
	4.8 in / 12 cm		1-LED 6max, Incl.
	5.3 in / 13.5 cm		–
	4.8 in / 12 cm		1-LED 6max, Incl.
	144 in / 366 cm		–
	140 in / 356 cm	AVL	110V, 220V















Wall Sconce		STW120	
	(S)		(SS1)
	13 lbs / 5.9 kg		3000 K
	4.5 in / 12.1 cm		2-LED 8max, Incl.
	18 in / 45.7 cm		-
	6 in / 15.2 cm		2-LED 8max, Incl.
	-		-
	-	AVL	110V, 220V



Wall Sconce		STW110	
	(S)		(SS1)
	7 lbs / 3 kg		3000 K
	4.8 in / 12 cm		2-LED 4max, Incl.
	9.7 in / 24.8 cm		-
	6 in / 15.2 cm		2-LED 4max, Incl.
	-		-
	-	AVL	110V, 220V



Flush Mounts		STW710	
	(S)		(SS1)
	21 lbs / 9.5 kg		3000 K

	15.5 in / 39.4 cm		5-LED 6max, Incl.
	5.7 in / 14.6 cm		-
	15.5 in / 39.4 cm		5-LED 6max, Incl.
	-		-
	-	AVL	110V, 220V

Infinite Aura

Inspired by the countless stars stretching across the night sky, the eternal roll of waves sparkling on the ocean, and the daily promise of sunrise and sunset, Infinite Aura is a constant companion and an endless inspiration. A ring of precision-cut crystals illuminated by LEDs embodies Schonbek's mastery of light, sending a never-ending reflection into infinity and creating an illusion of untold beauty, a sparkling vision reflecting the very light of light, which transcends time and passes from generation to generation.

Control Dim By App

Crystal Options



Crystals from Swarovski (S)

Finish Options



Black (-BK1)



Glimmer Silver (-SI1)



Glimmer Gold (-GD1)















White (-WH1)

































Pendant		MFC300	
 (S)	 (-WH1)		
	35 lbs / 15.8 kg		-

	30 in / 76 cm		1-LED 60max, Incl.
	9 in / 23 cm		-
	-		2-LED 60max, Incl.
	144 in / 366 cm		-
	144 in / 366 cm	AVL	110V, 220V, CCC













Pendant		MFC301	
	(S)		(-WH1)
	35 lbs / 15.8 kg		-
	30 in / 76 cm		1-LED 60max, Incl.
	2.5 in / 6 cm		-
	-		2-LED 60max, Incl.
	144 in / 366 cm		-
	144 in / 366 cm	AVL	110V, 220V, CCC







Pendant		MFC201	
	(S)		(-SI1)
	25 lbs / 11.3 kg		-
	22.5 in / 57 cm		1-LED 60max, Incl.
	2.5 in / 6 cm		-
	-		2-LED 60max, Incl.
	144 in / 366 cm		-
	144 in / 366 cm	AVL	110V, 220V, CCC



Pendant		MFC200	
	(S)		(-BK1)
	25 lbs / 11.3 kg		-





	22.5 in / 57 cm		1-LED 60max, Incl.
	8 in / 20 cm		-
	-		2-LED 60max, Incl.
	144 in / 366 cm		-
	144 in / 366 cm	AVL	110V, 220V, CCC











Pendant		MFC101	
	(S)		(-SI1)
	13 lbs / 5.9 kg		-

	15 in / 38 cm		1-LED 60max, Incl.
	2 in / 5 cm		-
	-		2-LED 60max, Incl.
	144 in / 366 cm		-
	144 in / 366 cm	AVL	110V, 220V, CCC















Pendant		MFC100	
	(S)		(-BK1)
	13 lbs / 5.9 kg		-













	15 in / 38 cm		1-LED 60max, Incl.
	8 in / 20 cm		-
	-		2-LED 60max, Incl.
	144 in / 366 cm		-
	144 in / 366 cm	AVL	110V, 220V, CCC

















Close to Ceiling		MFC220	
 (S)	 (-GD1)		
 25 lbs / 11.3 kg	 -		
 22.5 in / 57 cm	 110	1-LED 60max, Incl.	
 11 in / 28 cm	 110 ^h	-	
 -	 220	2-LED 60max, Incl.	
 -	 220 ^h	-	
 -	AVL	110V, 220V, CCC	















Close to Ceiling		MFC120	
 (S)	 (-WH1)		
 13 lbs / 5.9 kg	 -		
 15 in / 38 cm	 110	1-LED 60max, Incl.	
 10 in / 25 cm	 110 ^h	-	
 -	 220	2-LED 60max, Incl.	
 -	 220 ^h	-	
 -	AVL	110V, 220V, CCC	



Convertible Sconce		MFC121	
 (S)	 (-BK1)		
 13 lbs / 5.9 kg	 -		
 15 in / 38 cm	 110	1-LED 60max, Incl.	
 4.5 in / 11 cm	 110 ^h	-	
 -	 220	2-LED 60max, Incl.	
 -	 220 ^h	-	
 -	AVL	110V, 220V, CCC	



Convertible Sconce		MFC221	
	(S)		(-SI1)
	25 lbs / 11.3 kg		-

	22.5 in / 57 cm		1-LED 60max, Incl.
	4.5 in / 11 cm		-
	-		2-LED 60max, Incl.
	-		-
	-	AVL	110V, 220V, CCC

Madison

Rawness and refinement create harmony, shown in this unique piece. The hard landscape of its slab design has a low-impact on the interior flow and seamlessly propels a soft glow. With its characteristic, sleek pyramid cut, it retains a welcoming shine and a small footprint.

* Product only available in 220V

Crystal Options







Crystals from Swarovski (S)









Finish Options



Chrome (-CH1)



Recessed		SMA415	
	(S)		(-CH1)
	0.7 lbs / 0.3 kg		-

	3.5 in / 9 cm		-
	1.1 in / 3 cm		-
	3.5 in / 9 cm		1-GU5.3 35max
	-		-
	-	AVL	220V

A9950NR700169

Octa

This design's multiple angles support a philosophy that every seat in the house should be the best one – and have a distinct view. This represents a new kind of luxury. Further, the clear frame juts out with an elegant orientation to reveal a unique Swarovski crystal directing warm halogen light. Dynamic interior plans are complemented by this new, soft silhouette.

Crystal Options



Crystals from Swarovski (S)

Finish Options















Chrome (-CH1)



White (-WH1)















A9950NR700120 - CH1
A9950NR700121 - WH1

Recessed		SOT405	
	(S)		(-CH1)
	1.7 lbs / 0.7 kg		-
	3.5 in / 9 cm		-
	6.5 in / 16 cm		-
	3.5 in / 9 cm		1-GU5.3 35max
	-		-
	-	AVL	220V



A9950NR700125 - WH1
A9950NR700132 - CH1

Recessed		SOT415	
	(S)		(-CH1)
	1.65 lbs / 0.7 kg		-
	3.5 in / 9 cm		1-GU5.3 35max
	6.5 in / 16 cm		-
	3.5 in / 9 cm		-
	-		-
	-	AVL	110V



Quantum

These precious boxes of thick crystal pendeloques and gems cast on a stainless steel frame emit a dazzling light, both timeless and extravagant.

* Product only available in 110V

Crystal Options

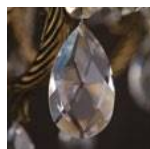

Spectra Crystal
(A)



Crystals from Swarovski
(S)



Crystals from Swarovski
Golden Shadow (GS)

Finish Options















Polished
Stainless Steel
(-401)

































Pendant		2267	
	(GS)		(-401)
	34 lbs / 15.3 kg		-

	47 in / 119 cm		17-B8 40max, Incl.
	9 in / 23 cm		-
	3.5 in / 9 cm		-
	144 in / 366 cm		-
	144 in / 366 cm	AVL	110V















Pendant		2274	
	(A)		(-401)
	41 lbs / 18.5 kg		-
	39 in / 99 cm		23-G11 40max, Incl.
	5 in / 13 cm		-
	15 in / 38 cm		-
	144 in / 366 cm		-
	144 in / 366 cm	AVL	110V















Pendant		2252	
	(GS)		(-401)
	8 lbs / 3.6 kg		-
	5.5 in / 14 cm		6-G11 40max, Incl.
	13 in / 33 cm		-
	5.5 in / 14 cm		-
	144 in / 366 cm		-
	144 in / 366 cm	AVL	110V







Pendant		2245	
	(A)		(-401)
	3 lbs / 1.4 kg		-
	4 in / 10 cm		2-G11 40max, Incl.
	5 in / 13 cm		-
	4 in / 10 cm		-
	144 in / 366 cm		-
	144 in / 366 cm	AVL	110V











Close to Ceiling		2124	
	(A)		(-401)
	12 lbs / 5.4 kg		-





	12 in / 30 cm		4-G9 40max, Incl.
	6 in / 15 cm		-
	12 in / 30 cm		-
	-		-
	-	AVL	110V











Wall Sconce		2236	
 (A)	 (-401)		
 6 lbs / 2.7 kg		-	

	5.5 in / 14 cm		3-G11 40max, Incl.
	13 in / 33 cm		-
	4.5 in / 11 cm		-
	-		-
	-	AVL	110V



Wall Sconce		2235	
 (A)	 (-401)		
 4 lbs / 1.8 kg		-	

	5.5 in / 14 cm		2-G11 40max, Incl.
	9 in / 23 cm		-
	4.5 in / 11 cm		-
	-		-
	-	AVL	110V



Wall Sconce		2225	
	(A)		(-401)
	12 lbs / 5.4 kg		-

	35.5 in / 90 cm		9-G11 40max, Incl.
	5 in / 13 cm		-
	3.5 in / 9 cm		-
	-		-
	-	AVL	110V



Wall Sconce		2224	
	(A)		(-401)
	9.5 lbs / 4.3 kg		-

	24 in / 61 cm		6-G11 40max, Incl.
	5 in / 13 cm		-
	3.5 in / 9 cm		-
	-		-
	-	AVL	110V



Wall Sconce		2220	
	(A)		(-401)
	2 lbs / 0.9 kg		-

	4.5 in / 11 cm		1-G11 40max, Incl.
	5 in / 13 cm		-
	3.5 in / 9 cm		-
	-		-
	-	AVL	110V



Refrax

Like rivers of diamonds, the striking forms of Refrax sparkle from within, evoking floating jewels beaming with light.

Canopy Options



110V*

*For 220V canopy information: please contact customer service

Crystal Options



Spectra Crystal (A)



Crystals from Swarovski (S)



Azurite (AZU)



Black Diamond (BLA)



Boa (BOA)



Bullet (BUL)



Jaguar (JAG)



Ocelot (OCE)



Golden Teak (TK)



Travertine (TRA)

Finish Options





Polished Stainless Steel (-401)















Pendant		RE4821	
	(OCE)		(-401)
	44 lbs / 19.8 kg		

	48 in / 122 cm		14-G9 40max, Incl.
	12.5 in / 32 cm		7-G9 50max, Incl.
	21 in / 53 cm		14-G9 40max, Incl.
	144 in / 366 cm		7-GU10 50 max, Incl.
	144 in / 366 cm	AVL	110V, 220V, CCC



Pendant		RE3214	
	(A)		(-401)
	21 lbs / 9.5 kg		

	32 in / 81 cm		8-G9 40max, Incl.
	8 in / 20 cm		5-GU10 50max, Incl.
	14.5 cm / 37 cm		8-G9 40max, Incl.
	144 in / 366 cm		5-GU10 50max, Incl.
	144 in / 366 cm	AVL	110V, 220V, CCC

Riviera

As glamorous as the French Riviera, with its rocky cliffs and tony yacht clubs, this dazzling chandelier is fit for royalty. Its pure geometry is complemented by luxurious tiers of precision-cut crystals draping from a mirror-like stainless steel ribbon.

Canopy Options



110V*

*For 220V canopy information:
please contact customer service

Crystal Options

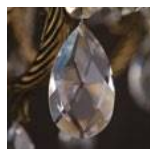

Spectra Crystal
(A)



Crystals from Swarovski
(S)

Finish Options



Brushed
Stainless Steel
(-16)















Polished
Stainless Steel
(-401)



















Pendant		RF2460	
	(A)		(-401)
	97 lbs / 43.7 kg		-





	24 in / 61 cm		24-G9 40max, Incl.
	43 in / 109 cm		-
	24 in / 61 cm		24-G9 40max, Incl.
	144 in / 366 cm		-
	144 in / 366 cm	AVL	110V, 220V











Pendant		RF2448	
	(A)		(-16)
	90 lbs / 40.5 kg		-

	49.5 in / 126 cm		16-G9 40max, Incl.
	10 in / 25 cm		-
	23.5 in / 60 cm		16-G9 40max, Incl.
	144 in / 366 cm		-
	144 in / 366 cm	AVL	110V, 220V



Wall Sconce		RF2402	
	(A)		(-401)
	8 lbs / 3.6 kg		-

	10 in / 25 cm		2-G9 40max, Incl.
	8 in / 20 cm		-
	4 in / 10 cm		2-G9 40max, Incl.
	-		-
	-	AVL	110V, 220V



Selene

Inspired by the ever-changing shapes of clouds in the sky, Selene intertwines within itself and is height adjustable for an endless amount of interior design combinations, limited only by one's imagination. Gleaming Swarovski prisms reflect the light in a myriad of patterns that are at once bold, dramatic and brilliant.

Dimmable by Phase Cut

Crystal Options



Spectra Crystal
(A)













Finish Options















Stainless Steel
(-SS1)

















Pendant		SPU140			39 in / 99 cm		6-LED 8max, Incl.
					11 in / 28 cm		-
	(A)		(-SS1)		8.5 in / 22 cm		6-LED 8max, Incl.
	39 lbs / 17.6 kg		-		144 in / 366 cm		-
					144 in / 366 cm	AVL	110V, 220V, CCC















Pendant		SPU160	
	(A)		(-SS1)
	58 lbs / 26.1 kg		-
	37 in / 94 cm		8-LED 8max, Incl.
	13.5 in / 34 cm		-
	18 in / 46 cm		8-LED 8max, Incl.
	144 in / 366 cm		-
	144 in / 366 cm	AVL	110V, 220V, CCC







Pendant		SPU150	
	(A)		(-SS1)
	44 lbs / 19.8 kg		-
	18 in / 46 cm		6-LED 8max, Incl.
	13.5 in / 34 cm		-
	18 in / 46 cm		6-LED 8max, Incl.
	144 in / 366 cm		-
	144 in / 366 cm	AVL	110V, 220V, CCC











Pendant		SPU130	
	(A)		(-SS1)
	27 lbs / 12.2 kg		-





	27 in / 69 cm		4-LED 8max, Incl.
	11 in / 28 cm		-
	8.5 in / 22 cm		4-LED 8max, Incl.
	144 in / 366 cm		-
	144 in / 366 cm	AVL	110V, 220V, CCC











Pendant		SPU120	
	(A)		(-SS1)
	11 lbs / 5 kg		-

	14.5 in / 37 cm		2-LED 8max, Incl.
	7.5 in / 19 cm		-
	8.5 in / 22 cm		2-LED 8max, Incl.
	144 in / 366 cm		-
	144 in / 366 cm	AVL	110V, 220V, CCC



Wall Sconce		SPU170	
 (A)	 (-SS1)		
 9 lbs / 4.1 kg	 -		

 14.5 in / 37 cm	 110	2-LED 8max, Incl.
 7.5 in / 19 cm	 110	-
 7 in / 18 cm	 220	2-LED 8max, Incl.
 -	 220	-
 -	AVL	110V, 220V, CCC

SoHo

Inspired by the image of birds perched along a power line and designed with the ability to adapt to a variety of interior scenarios, SoHo fixtures have an airy, sculptural presence. The arms of the pendants can be aligned or can be set at angles to make a more dramatic statement. With faceted shades oriented up, SoHo pendants provide ambient illumination that is ideal for dining or entertainment spaces, and when shades are oriented down, the pendants work well for areas, like kitchens, that benefit from task-style lighting. Similarly, wall sconces are easily arranged in pairs with faceted shades oriented to deliver directional lighting as desired.

Finish Options



White
(-B06)















Black
(-B51)







Bath Bar		LJ1214	
	-		(-B06)
	10.1 lbs / 4.6 kg		-

	37 in / 94 cm		8-B10 40max
	9.9 in / 25.1 cm		-
	6.7 in / 17 cm		-
	-		-
	-	AVL	110V



Bath Bar		LJ1210	
	-		(-B51)
	4.8 lbs / 2.2 kg		-

	24.9 in / 63.3 cm		4-B10 40max
	8.1 in / 20.6 cm		-
	4.5 in / 11.4 cm		-
	-		-
	-	AVL	110V



Pendant		LJ1012	
	–		(-B51)
	19.8 lbs / 9.1 kg		–

	6.4 in / 16.3 cm		10-B10 40max
	56.2 in / 48 cm		–
	–		10-B35 40max
	42in / 106.8 cm – Rod		–
	122 in / 310 cm	AVL	110V, 220V



Pendant		LJ1010	
	–		(-B06)
	7.2 lbs / 3.3 kg		–

	3.5 in / 9 cm		4-B10 40max
	8.4 in / 21.5 cm		–
	–		4-B35 40max
	42in / 106.8 cm – Rod		–
	122 in / 310 cm	AVL	110V, 220V

Trilliane Strands

The ethereal luminosity of lush crystal strands brings a whimsical element to the iconic Trilliane chandelier. The garlands mingle with glimmering inverted pendeloques, created using a historically revolutionary technique that evokes the rawness of mineral crystal.

Canopy Options



110V*



110V*

*For 220V canopy information: please contact customer service

Crystal Options



Heritage Crystal (H)



Spectra Crystal (A)

Finish Options















Polished Stainless Steel (-401)



















Pendant		TR2413	
	(H)		(-401)
	57 lbs / 25.7 kg		-





	24 in / 61 cm		6-GU10 50max, Incl.
	70.5 in / 179 cm		-
	-		6-GU10 50max, Incl.
	144 in / 366 cm		-
	144 in / 366 cm	AVL	110V, 220V











Pendant		TR4813	
	(H)		(-401)
	83 lbs / 37.4 kg		-













	45 in / 114 cm		8-GU10 50max, Incl.
	48 in / 122 cm		-
	25 in / 64 cm		8-GU10 50max, Incl.
	144 in / 366 cm		-
	144 in / 366 cm	AVL	110V, 220V















Pendant		TR4812	
	(H)		(-401)
	64 lbs / 28.8 kg		-

	45 in / 114 cm		8-GU10 50max, Incl.
	28 in / 71 cm		-
	25 in / 64 cm		8-GU10 50max, Incl.
	144 in / 366 cm		-
	144 in / 366 cm	AVL	110V, 220V



Pendant		TR4811	
	(H)		(-401)
	58 lbs / 26.1 kg		-
	45 in / 114 cm		8-GU10 50max, Incl.
	15 in / 38 cm		-
	25 in / 64 cm		8-GU10 50max, Incl.
	144 in / 366 cm		-
	144 in / 366 cm	AVL	110V, 220V



Pendant		TR1813	
	(A)		(-401)
	41 lbs / 18.5 kg		-
	21 in / 53 cm		5-GU10 50max, Incl.
	72 in / 183 cm		-
	-		5-GU10 50max, Incl.
	144 in / 366 cm		-
	144 in / 366 cm	AVL	110V, 220V



Close to Ceiling		TR4803	
	(H)		(-401)
	81 lbs / 36.5 kg		-
	45 in / 114 cm		8-GU10 35max, Incl.
	48.5 in / 123 cm		-
	25 in / 64 cm		8-GU10 35max, Incl.
	-		-
	-	AVL	110V, 220V



Close to Ceiling		TR4802	
	(H)		(-401)
	62 lbs / 27.9 kg		-
	45 in / 114 cm		8-GU10 35max, Incl.
	28.5 in / 72 cm		-
	25 in / 64 cm		8-GU10 35max, Incl.
	-		-
	-	AVL	110V, 220V















Close to Ceiling		TR4801	
	(H)		(-401)
	56 lbs / 25.2 kg		-
	45 in / 114 cm		8-GU10 35max, Incl.
	15.5 in / 39 cm		-
	25 in / 64 cm		8-GU10 35max, Incl.
	-		-
	-	AVL	110V, 220V















Close to Ceiling		TR1201	
	(H)		(-401)
	16 lbs / 7.2 kg		-
	17 in / 43 cm		4-GU10 35max, Incl.
	10.5 in / 27 cm		-
	-		4-GU10 35max, Incl.
	-		-
	-	AVL	110V, 220V



Wall Sconce		TR0833	
	(A)		(-401)
	6 lbs / 2.7 kg		-
	10 in / 25 cm		2-G9 40max, Incl.
	21 in / 53 cm		-
	7.5 in / 19 cm		2-G9 40max, Incl.
	-		-
	-	AVL	110V, 220V



Wall Sconce		TR0832	
	(A)		(-401)
	5 lbs / 2.3 kg		-
	10 in / 25 cm		2-G9 40max, Incl.
	13.5 in / 34 cm		-
	7.5 in / 19 cm		2-G9 40max, Incl.
	-		-
	-	AVL	110V, 220V

Vega

Multidirectional light exudes from this crystal fixture. The textural casing brings charm and balance to every home's design. Those dedicated to a higher standard of craftsmanship appreciate the sheer versatility of the sconce form and how it suits all spaces. Made with Swarovski's signature impeccable brilliance, as showcased in its Swarovski crystal accents.

Dimmable By 0-10V

* Product only available in 220V

Crystal Options



Crystals from Swarovski (S)

Finish Options



Gold Plated (-G01)







Chrome (-CH1)











Chrome Matte (-CH3)





Recessed		SVA405	
	(S)		(-CH1)
	0.7 lbs / 0.3 kg		-





	3.1 in / 8 cm		-
	3.9 in / 10 cm		-
	3.1 in / 8 cm		1-GU5.3 35max
	-		-
	-	AVL	220V





S Crystal
 A8992NR020010CRY - CH1
 A8992NR030010CRY - G01
 A8992NR040010CRY - CH3

AB Crystal
 A8992NR020010ABZ - CH1
 A8992NR030010ABZ - G01
 A8992NR040010ABZ - CH3



A8992NR020031CRY - CH1
A8992NR030031CRY - G01

Flush Mounts		SVA400	
	(S)		(-G01)
	1.5 lbs / 0.7 kg		-

	5.1 in / 13 cm		-
	2.8 in / 7 cm		-
	5.1 in / 13 cm		1-LED 6max, Incl.
	-		-
	-	AVL	220V



Verve

Personality-led design is the hallmark of any eclecticism devotee. This energizing presence is born from a tower of Swarovski crystals with a resplendent backlit style. It's one way to reimagine the contemporary with great design ingenuity. Fitting with midcentury modern furnishings that mirror an element of arresting shapes and quirky accents.

Dimmable By Line Voltage

Crystal Options



Crystals from Swarovski
(S)





Finish Options













Stainless Steel
(-SS1)

















Wall Sconce		SVR625	
 (S)	 (-SS1)		
 6.3 lbs / 2.8 kg	 -		

 4.52 in / 11 cm	 7-G9 25max
 24 in / 61 cm	 -
 3.7 in / 9 cm	 -
 -	 -
 -	 AVL 110V, 220V, CCC

A9950NR700214 - 220V
 A9950NR700256 - 110V















A9950NR700212 - 220V
A9950NR700255 - 110V

Wall Sconce		SVR615	
	(S)		(-SS1)
	5 lbs / 2.3 kg		-
	4.52 in / 11 cm		5-G9 25max
	18 in / 46 cm		-
	3.7 in / 9 cm		-
	-		-
	-	AVL	110V, 220V, CCC















A9950NR700210 - 220V
A9950NR700254 - 110V

Wall Sconce		SVR605	
	(S)		(-SS1)
	2.4 lbs / 1.1 kg		-
	4.52 in / 11 cm		1-G9 25max
	5 in / 13 cm		-
	3.7 in / 9 cm		-
	-		-
	-	AVL	110V, 220V, CCC



A9950NR700225 - 220V
A9950NR700224 - 110V

Wall Sconce		SVR405	
	(S)		(-SS1)
	2.4 lbs / 1.1 kg		-
	2.5 in / 6 cm		3-G9 25max
	12 in / 30 cm		-
	3.7 in / 9 cm		3-G8.5 25max
	-		-
	-	AVL	220V, CCC



Close to ceiling



Bagatelle
1239
AVL 110V, 220V
p.30

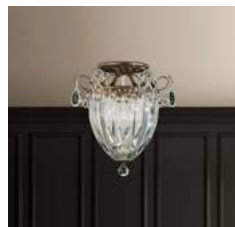

Bagatelle
1242
AVL 110V, 220V
p.30



Baronet
BN1416
AVL 110V, 220V, CCC
p.322



Baronet
BN1424
AVL 110V, 220V, CCC
p.322



Camelot
2616
AVL 110V
p.43



Camelot
2618
AVL 110V
p.43



Cassini
CA2525
AVL 110V, 220V
p.329



Chantant
CH0802
AVL 110V
p.341



Chantant
CH1201
AVL 110V
p.341



Chantant
CH1202
AVL 110V
p.340

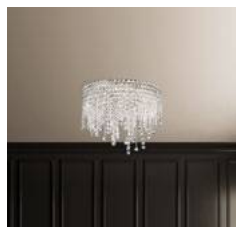

Chantant
CH1801
AVL 110V
p.340



Chantant
CH2401
AVL 110V
p.340

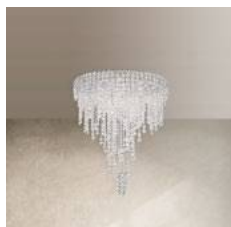

Chantant
CH2402
AVL 110V
p.339



Chantant
CH2403
AVL 110V
p.339



Chantant
CH4802
AVL 110V
p.338



Chantant
CH4803
AVL 110V
p.338



Chrysalita
CM8419
AVL 110V, 220V
p.56



Chrysalita
CM8426
AVL 110V, 220V
p.56



Circulus
DR1401
AVL 110V
p.352



Early American
ER1211
AVL 110V
p.278



Early American
ER1201
AVL 110V
p.278



Esteracae
DN1218
AVL 110V
p.363



Esteracae
DN1224
AVL 110V
p.363



Filigrae
FE7206
AVL 110V
p.74



Glissando
STW710
AVL 110V, 220V
p.369



La Scala
5345
AVL 110V
p.92

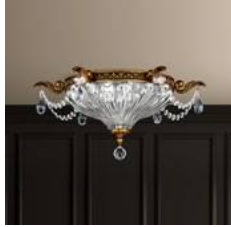

Milano
5633
AVL 110V, 220V
p.102



Petit Crystal Deluxe
5890
AVL 110V, 220V
p.134



Petit Crystal Deluxe
5891
AVL 110V, 220V
p.134



Petit Crystal Deluxe
5892
AVL 110V, 220V
p.133



Petit Crystal Deluxe
5893
AVL 110V, 220V
p.133



Petit Crystal Deluxe
5894
AVL 110V, 220V
p.133



Petit Crystal Deluxe
5895
AVL 110V, 220V
p.133



Petit Crystal Deluxe
5896
AVL 110V, 220V
p.132



Petit Crystal Deluxe
5897
AVL 110V, 220V
p.132



Petit Crystal Deluxe
5898
AVL 110V, 220V
p.132



Plaza
6690
AVL 110V, 220V
p.143



Plaza
6692
AVL 110V, 220V
p.143



Plaza
6694
AVL 110V, 220V
p.143



Quantum
2124
AVL 110V
p.387



Renaissance
3784
AVL 110V, 220V
p.152



Renaissance
3785
AVL 110V, 220V
p.152



**Renaissance
Rock Crystal**
3584
AVL 110V, 220V
p.159



Sarella
RS8347
AVL 110V, 220V
p.176



Sarella
RS8348
AVL 110V, 220V
p.176

Overview



Tiara
9841
AVL 110V
p.209



Tiara
9843
AVL 110V
p.209



Tiara
9845
AVL 110V
p.208



Trilliane
5796
AVL 110V, 220V
p.226



Trilliane
5797
AVL 110V, 220V
p.226



Trilliane
5867
AVL 110V, 220V
p.226



Trilliane
5868
AVL 110V, 220V
p.225



Trilliane
5877
AVL 110V, 220V
p.225



Trilliane Strands
TR1201
AVL 110V, 220V
p.414



Trilliane Strands
TR4801
AVL 110V, 220V
p.414



Trilliane Strands
TR4802
AVL 110V, 220V
p.418



Trilliane Strands
TR4803
AVL 110V, 220V
p.418

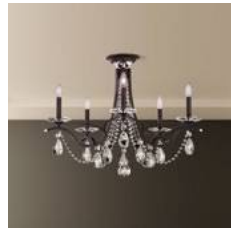

Vesca
VA8312
AVL 110V
p.300



Vega
SVA400
AVL 220V
p.423

Wall Sconces



Arlington
1301
AVL 110V
p.23



Bagatelle
1240
AVL 110V, 220V
p.31



Bordeaux
5766
AVL 110V
p.37



Century
1701
AVL 110V, 220V
p.51



Century
1702
AVL 110V, 220V
p.51



Century
1703
AVL 110V, 220V
p.51



Chantant
CH0832
AVL 110V
p.343



Chantant
CH0833
AVL 110V
p.343



Chantant
CH1232
AVL 110V
p.343



Chantant
CH2440
AVL 110V
p.342



Chantant
CH3640
AVL 110V
p.342



Chrysalita
CM8519
AVL 110V, 220V
p.57



Emilea
MA1002
AVL 110V, 220V
p.285



Esmerly
AR1002
AVL 110V
p.241



Filigrae
FE7002
AVL 110V
p.75



Fyra
SQB110
AVL 110V, 220V
p.291



Glissando
STW110
AVL 110V, 220V
p.368



Glissando
STW120
AVL 110V, 220V
p.368

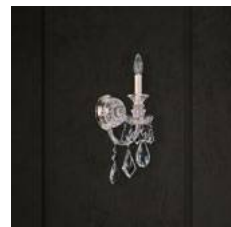

Hamilton
5701
AVL 110V, 220V
p.81



Infinite Aura
MFC120
AVL 110V, 220V
p.376

Overview



Infinite Aura
MFC220
AVL 110V, 220V
p.376



Jasmine
9671
AVL 110V
p.247



Jasmine
9672
AVL 110V
p.247



La Scala
5001
AVL 110V
p.93



La Scala
5069
AVL 110V
p.93



La Scala
5070
AVL 110V
p.93



La Scala
5071
AVL 110V
p.93



Milano
5641
AVL 110V, 220V
p.103



Milano
5642
AVL 110V, 220V
p.103



Milano
5643
AVL 110V, 220V
p.103



Modique
MD1002
AVL 110V
p.253



New Orleans
3650
AVL 110V
p.111



New Orleans
3651
AVL 110V
p.110



New Orleans
3652
AVL 110V
p.110



Olde World
6805
AVL 110V, 220V
p.123



Olde World
6806
AVL 110V, 220V
p.123



Olde World
6807
AVL 110V, 220V
p.123



Olde World
6808
AVL 110V, 220V
p.123



Petit Crystal Deluxe
6600
AVL 110V, 220V
p.135



Quantum
2220
AVL 110V
p.389



Quantum
2224
AVL 110V
p.389



Quantum
2235
AVL 110V
p.388

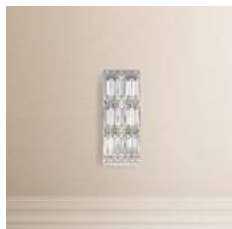

Quantum
2236
AVL 110V
p.388



Renaissance
3756
AVL 110V, 220V
p.153



Renaissance
3758
AVL 110V, 220V
p.153



Renaissance
3761
AVL 110V, 220V
p.153



Renaissance
3762
AVL 110V, 220V
p.153



Rivendell
7855
AVL 110V, 220V
p.165



Riviera
RF2402
AVL 110V, 220V
p.399



Sarella
RS8324
AVL 110V, 220V
p.179



Sarella
RS8331
AVL 110V, 220V
p.178



Sarella
RS8332
AVL 110V, 220V
p.178



Sarella
RS8333
AVL 110V, 220V
p.177



Sarella
RS8336
AVL 110V, 220V
p.177



Savannah
CF1001
AVL 110V, 220V
p.183



Selene
SPU170
AVL 110V, 220V
p.405



Sonatina
ST1939
AVL 110V
p.189



Sterling
2990
AVL 110V, 220V
p.205



Sterling
2991
AVL 110V, 220V, CCC
p.205



Sterling
2992
AVL 110V, 220V, CCC
p.205



Tassau
GT1002
AVL 110V
p.269



Tassau
GT1011
AVL 110V
p.269



Trilliane
5876
AVL 110V, 220V
p.227



Trilliane
5888
AVL 110V, 220V
p.227



Trilliane Strands
TR0832
AVL 110V, 220V
p.419

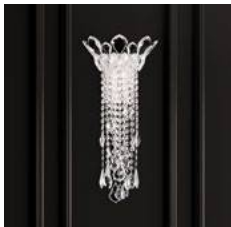

Trilliane Strands
TR0833
AVL 110V, 220V
p.419

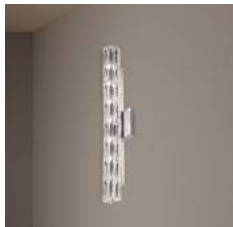

Verve
SVR625
AVL 110V, 220V, CCC
p.426

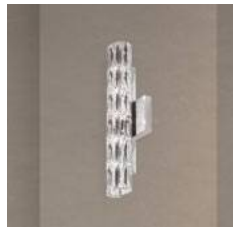

Verve
SVR615
AVL 110V, 220V, CCC
p.427



Verve
SVR605
AVL 110V, 220V, CCC
p.427



Verve
SVR405
AVL 220V, CCC
p.427

Overview



Vesca
VA8332
AVL 110V
p.301

Recessed



Madison
SMA415
AVL 220V
p.379

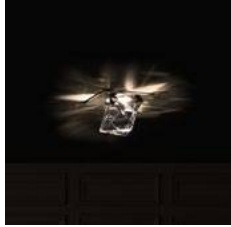

Octa
SOT415
AVL 110V
p.381

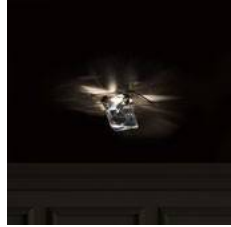

Octa
SOT405
AVL 220V
p.381



Vega
SVA405
AVL 220V
p.422

Bath Bar



Baronet
BN1224
AVL 110V, 220V, CCC
p.323



Baronet
BN1236
AVL 110V, 220V, CCC
p.323



Circulus
DR2440
AVL 110V
p.353



Early American
ER2440
AVL 110V
p.279



SoHo
LJ1214
AVL 110V
p.409



SoHo
LJ1210
AVL 110V
p.410

Convertible



Infinite Aura
MFC121
AVL 110V, 220V, CCC
p.376



Infinite Aura
MFC221
AVL 110V, 220V, CCC
p.377

Table Lamp



Sarella
RS8301
AVL 110V, 220V
p.179

Index by Core

1238	28	2628	42	3784	152	5798	224	6805	123
1239	30	2638	42	3785	152	5799	224	6806	123
1240	31	2642	41	3787	149	5846	223	6807	123
1241	29	2716	69	3790	149	5847	222	6808	123
1242	30	2725	68	3792	149	5848	222	6809	122
1243	29	2726	68	3795	148	5849	222	6811	122
1246	28	2727	67	3796	148	5851	222	6813	122
1248	28	2990	205	5001	93	5853	223	6814	122
1260	27	2991	205	5007	91	5855	223	6815	121
1301	23	2992	205	5008	91	5856	221	6816	121
1302	22	2994	204	5011	91	5858	221	6817	120
1303	22	2995	204	5013	89	5867	226	6818	120
1305	22	2996	203	5069	93	5868	225	6860	120
1308	22	2997	203	5070	93	5871	221	6861	119
1310	21	2998	203	5071	93	5872	220	6949	193
1558	127	2999	202	5072	90	5873	220	6952	193
1560	127	3572	158	5073	90	5875	219	6967	192
1562	127	3573	157	5074	90	5876	227	7855	165
1564	126	3584	159	5075	90	5877	225	7863	164
1701	51	3587	158	5345	92	5888	227	7864	163
1702	51	3601	202	5535	85	5890	134	7866	164
1703	51	3608	202	5536	84	5891	134	7882	164
1704	50	3610	202	5633	102	5892	133	9671	247
1705	50	3612	201	5641	103	5893	133	9672	247
1707	50	3648	109	5642	103	5894	133	9675	246
1709	49	3650	111	5643	103	5895	133	9676	246
1712	49	3651	110	5676	101	5896	132	9679	246
1716	48	3652	110	5677	101	5897	132	9685	245
1718	47	3656	109	5679	100	5898	132	9690	245
1829	48	3657	108	5682	100	6600	135	9695	244
2124	387	3658	108	5683	99	6616	130	9841	209
2220	389	3660	107	5685	98	6618	131	9843	209
2224	389	3756	153	5686	98	6670	142	9845	208
2225	389	3758	153	5688	97	6671	142	AR1002	241
2235	388	3761	153	5701	81	6672	141	AR1004	240
2236	388	3762	153	5708	79	6673	141	AR1006	240
2245	386	3769	151	5737	80	6674	141	AR1008	240
2252	386	3770	151	5766	37	6675	140	AR1012	239
2267	385	3771	151	5770	36	6677	139	BF1004	261
2274	386	3772	151	5771	36	6678	140	BF1006	260
2616	43	3773	147	5775	36	6680	140	BN1016	321
2618	43	3774	150	5782	35	6690	143	BN1024	321
2622	42	3780	150	5796	226	6692	143	BN1033	320
2626	42	3783	150	5797	226	6694	143	BN1224	323

BN1236	323	DN1018	362	LR1010	212	RS8341	175	STW120	368
BN1416	322	DN1024	362	MA1002	285	RS8343	175	STW310	367
BN1424	322	DN1036	361	MA1003	284	RS8344	174	STW410	367
CA2525	329	DN1218	363	MA1004	284	RS8345	174	STW510	366
CA3724	328	DN1224	363	MA1005	283	RS8346	174	STW710	369
CA3939	327	DR1401	352	MA1006	283	RS8347	176	SVA400	423
CF1001	183	DR1412	351	MA1008	283	RS8348	176	SVA405	422
CF1006	182	DR2412	350	MA1012	282	RS8349	174	SVR405	427
CH0802	341	DR2440	353	MD1002	253	RS8350	173	SVR605	427
CH0812	337	DV1212	63	MD1005	252	RS8351	173	SVR615	427
CH0832	343	DV1515	62	MD1006	252	RS8352	173	SVR625	426
CH0833	343	DV1818	61	MD1012	251	RS8415	169	TC1018	235
CH1201	341	ER1006	277	MD1015	252	RS83061	172	TC1024	235
CH1202	340	ER1008	277	MFC100	375	RS83081	172	TC1036	234
CH1211	337	ER1016	277	MFC101	375	RS83101	171	TR0832	419
CH1212	337	ER1018	276	MFC120	376	RS83151	171	TR0833	419
CH1232	343	ER1201	278	MFC121	376	RS84151	170	TR1201	418
CH1801	340	ER1211	278	MFC200	375	SCE111	357	TR1813	417
CH1812	336	ER2440	279	MFC201	374	SCE121	357	TR2413	415
CH1813	336	FE7002	75	MFC220	376	SCE131	356	TR4801	418
CH2401	340	FE7006	73	MFC221	377	SHK200	313	TR4802	418
CH2402	339	FE7018	72	MFC300	373	SHK300	312	TR4803	418
CH2403	339	FE7066	73	MFC301	374	SMA415	379	TR4811	417
CH2412	335	FE7206	74	MX8340	347	SOT405	381	TR4812	416
CH2413	333	GT1002	269	MX8343	347	SOT415	381	TR4813	416
CH2440	342	GT1006	268	MX8346	346	SPU120	404	VA8304	298
CH3611	335	GT1007	268	MX8349	347	SPU130	404	VA8305	298
CH3612	335	GT1009	268	NV3904	115	SPU140	402	VA8306	297
CH3640	342	GT1011	269	NV3905	115	SPU150	403	VA8312	300
CH4802	338	GT1012	268	NV3907	114	SPU160	403	VA8322	297
CH4803	338	GT1015	265	RE3214	393	SPU170	404	VA8332	301
CH4811	335	GT1016	267	RE4821	393	SQB110	291	VA8335	297
CH4812	334	GT1017	267	RF2402	390	SQB410	290	VA8336	296
CH4813	334	GT1019	267	RF2448	398	SQB510	290	VA8339	295
CJ1004	257	GT1022	266	RF2460	399	SQB610	290	VA8355	296
CJ1006	256	GT1025	266	RS8301	179	SQB710	289	VA8435	299
CM8319	55	LJ1010	411	RS8310	171	SRI400	309	VA8436	299
CM8326	55	LJ1012	411	RS8315	170	SRI500	308	WM1006	197
CM8334	54	LJ1210	410	RS8324	178	ST1849	188	WM1008	196
CM8419	56	LJ1214	409	RS8331	178	ST1852	188		
CM8426	56	LR1002	215	RS8332	178	ST1939	189		
CM8519	57	LR1004	214	RS8333	177	ST1946	188		
CW1006	317	LR1006	213	RS8336	177	ST1952	187		
CW1008	316	LR1008	213	RS8340	175	STW110	368		

North and South America

Swarovski Lighting, Ltd.
61 Industrial Boulevard
Plattsburgh, New York 12901-1908
USA
Tel. +1 800 836 1892
or +1 518 563 7500
Fax +1 518 563 4228
lighting.na@swarovski-lighting.com

Europe

Swarovski International Distribution AG
Swarovski Lighting
Dröschstrasse 15
FL-9495 Triesen
Principality of Liechtenstein
+423 399 5656
lighting.europe@swarovski.com

AUSTRIA
+43 5224 500 5656

FRANCE
+33 1 44 76 15 53

GREAT BRITAIN
+44 845 607 0341

Africa / Middle East / India

Swarovski Middle East FZE
Swarovski Lighting
P.O. Box 17128
Jebel Ali Free Zone, Junction 6
Dubai UAE
+971 4 881 65 62
lighting.me@swarovski.com
lighting.india@swarovski.com

Australia / Asia Pacific

Swarovski Singapore Trading PTE LTD.
Swarovski Lighting
2 Alexandra Road
Unit No. 03-01 Delta House
159919, Singapore
+65 6661 6393
lighting.ap@swarovski.com

Swarovski (Shanghai) Trading Co., Ltd.
Swarovski Lighting
RS803 Building A, China Overseas
International Center
Lane 838, Huangpi Road South,
Huangpu District
Shanghai 200025, China
+86 21 23069888
lighting.ap@swarovski.com

schonbek.com

PUBLISHER: Swarovski Lighting, Ltd., Plattsburgh, New York

© 2020 Swarovski Lighting, Ltd.

Art Direction and Performance: Swarovski Lighting Ltd., Plattsburgh, New York

All rights reserved. The publication, transfer, or any other form of copying contents or parts thereof, in any form, is forbidden, unless previously agreed in writing by Swarovski. We reserve the right to change prices and technical details. We will not be held responsible for errors in printing or terminology. Terms and conditions apply. With the issuing of this pricelist/catalog, all previous prices/information cease to apply. We will be happy to provide information on the country-specific availability of the items described upon request. All measurements given in cm/inch. The currently valid General Terms and Conditions can be found on our website schonbek.com